



ETA-Danmark A/S  
Göteborg Plads 1  
DK-2150 Nordhavn  
Tel. +45 72 24 59 00  
Internet [www.etadanmark.dk](http://www.etadanmark.dk)

Authorised and notified  
according to Article 29 of the  
Regulation (EU)  
No 305/2011 of the European  
Parliament and of the Council  
of 9 March 2011

MEMBER OF EOTA



## European Technical Assessment ETA-21/0647 of 2021/07/05

### I General Part

**Technical Assessment Body issuing the ETA and designated according to Article 29 of the Regulation (EU) No 305/2011: ETA-Danmark A/S**

**Trade name of the construction product:**

Tytan Professional B1 Fire Wrap  
Also placed on the market under the name  
Quilosa Professional B1 Fire Wrap

**Product family to which the above construction product belongs:**

Fire Stopping and Sealing Product:  
• Penetration Seals

**Manufacturer:**

Selena FM S.A.  
Strzegomska 2-4  
PL-53-611 Wroclaw

**Manufacturing plant:**

A/003

**This European Technical Assessment contains:**

68 pages including 1 annex which form an integral part of the document

**This European Technical Assessment is issued in accordance with Regulation (EU) No 305/2011, on the basis of:**

EAD 350454-00-1104

**This version replaces:**

-

**Translations of this European Technical Assessment in other languages shall fully correspond to the original issued document and should be identified as such.**

**Communication of this European Technical Assessment, including transmission by electronic means, shall be in full. However, partial reproduction may be made, with the written consent of the issuing Technical Assessment Body. Any partial reproduction has to be identified as such.**

Table of Contents

1	Technical description of the product .....	4
2	Specification of the intended uses of the product in accordance with the applicable European Assessment Document (Hereinafter EAD): EAD 350454-00-1104.....	5
3	Performance of the product and references to the methods used for its assessment .....	6
4	ASSESSMENT AND VERIFICATION OF CONSTANCY OF PERFORMANCE (HEREINAFTER AVCP) SYSTEM APPLIED, WITH REFERENCE TO ITS LEGAL BASE.....	7
5	Technical details necessary for the implementation of the AVCP system, as provided for in the applicable EAD .....	7
A.1	Rigid wall constructions with wall thickness of minimum 150 mm.....	9
A.1.1	Tytan Professional B1 Fire Wrap penetration seals, in 100 mm thick Tytan Professional B1 Fire Mortar Gypsum seals in rigid walls with insulated metal pipes.....	9
A.1.2	Tytan Professional B1 Fire Wrap penetration seals, in 100 mm thick Tytan Professional B1 Fire Mortar Gypsum seals in rigid walls with plastic pipes .....	12
A.2	Rigid floor constructions with a minimum thickness 150 mm .....	13
A.2.1	Tytan Professional B1 Fire Wrap penetration seals, in 100 mm thick Tytan Professional B1 Fire Mortar Gypsum seals in rigid floors, with insulated metal pipes.....	13
A.2.2	Tytan Professional B1 Fire Wrap penetration seals, in 100 mm thick Tytan Professional B1 Fire Mortar Gypsum seals in rigid floors, with insulated metal pipes.....	15
A.2.3	Tytan Professional B1 Fire Wrap penetration seal for insulated metal pipes, in Tytan Professional B1 Fire Mortar Gypsum Seal, in rigid floors .....	17
A.2.4	Tytan Professional B1 Fire Wrap penetration seals, in 100 mm deep Tytan Professional B1 Fire Mortar Gypsum seals in rigid floors, with plastic pipes .....	20
A.2.5	Tytan Professional B1 Fire Wrap penetration seals, in 100 mm thick Tytan Professional B1 Fire Mortar Gypsum seals in rigid floors, with plastic pipes .....	24
A.2.6	Tytan Professional B1 Fire Wrap penetration seals, in Tytan Professional B1 Fire Mortar Gypsum seals in rigid floors, with plastic pipes .....	28
A.2.7	Tytan Professional B1 Fire Wrap penetration seals, in 150 mm thick Tytan Professional B1 Fire Mortar Gypsum seals in rigid floors, with plastic pipes .....	35
A.2.8	Tytan Professional B1 Fire Wrap penetration seals, in 50 mm deep Tytan Professional B1 Fire Mortar Gypsum seals, backed with 50 mm stone wool, in rigid floors, with plastic pipes .....	39
A.3	Flexible and rigid wall constructions with a minimum thickness 100 mm .....	40
A.3.1	Tytan Professional B1 Fire Wrap penetration seal for insulated metal pipes, in seals comprising 25 mm deep Tytan Professional B1 Fire Mortar Gypsum to both faces backed with 50 mm mineral fibre board, installed within flexible or rigid wall.....	40
A.3.2	Tytan Professional B1 Fire Wrap penetration seal for composite pipes, in seals comprising 25 mm deep Tytan Professional B1 Fire Mortar Gypsum to both faces backed with 50 mm mineral fibre board, installed within flexible or rigid wall.....	42
A.3.3	Tytan Professional B1 Fire Wrap penetration seal for insulated metal & composite pipes, in seals comprising 25 mm deep Tytan Professional B1 Fire Mortar Gypsum to both faces backed with 50 mm mineral fibre board, installed within flexible or rigid wall .....	43
A.3.4	Tytan Professional B1 Fire Wrap penetration seal for insulated metal pipes, in seals comprising 50 mm deep Tytan Professional B1 Fire Mortar Gypsum to both faces, installed within flexible or rigid wall.....	44
A.4	Rigid wall constructions with floor thickness of minimum 150 mm.....	46
A.4.1	Tytan Professional B1 Fire Wrap penetration seal for insulated metal pipes, in 1x Tytan Professional B1 Fire Board 2-S seals, in rigid walls.....	46
A.4.2	Tytan Professional B1 Fire Wrap penetration seal for insulated metal pipes, in 2x Tytan Professional B1 Fire Board 2-S seals, in rigid walls.....	47
A.5	Rigid floor constructions with floor thickness of minimum 150 mm .....	49
A.5.1	Tytan Professional B1 Fire Wrap penetration seal for plastic pipes, in 1x Tytan Professional B1 Fire Board 2-S, in rigid floors .	49
A.5.2	Tytan Professional B1 Fire Wrap penetration seal for insulated metal pipes, in 1x Tytan Professional B1 Fire Board 2-S, in rigid floors.....	50
A.5.3	Tytan Professional B1 Fire Wrap penetration seal for insulated metal pipes in 2x Tytan Professional B1 Fire Board 2-S (separated), in rigid floors.....	51
A.5.4	Tytan Professional B1 Fire Wrap penetration seal for insulated metal pipes, in 2x Tytan Professional B1 Fire Board 2-S (back to back), in rigid floors.....	52
A.6	Flexible wall constructions according to 2. 1) .....	54

A.6.1	Tytan Professional B1 Fire Wrap penetration seal for insulated metal pipes, in 2x Tytan Professional B1 Fire Board 1-S in flexible or rigid walls .....	54
A.6.2	Tytan Professional B1 Fire Wrap penetration seal for insulated metal pipes, in 2x Tytan Professional B1 Fire Board 1-S, in flexible or rigid walls .....	56
A.6.3	Tytan Professional B1 Fire Wrap penetration seal for insulated metal pipes, in 2x Tytan Professional B1 Fire Board 1-S, in flexible or rigid walls .....	58
A.6.4	Tytan Professional B1 Fire Wrap penetration seal for insulated metal pipes, in 2x Tytan Professional B1 Fire Board 1-S, in flexible or rigid walls .....	59
A.6.5	Tytan Professional B1 Fire Wrap penetration seal for plastic pipes, in 2x Tytan Professional B1 Fire Board 1-S, in flexible or rigid walls .....	60
A.6.6	Penetration seal in Tytan Professional B1 Fire Mortar Gypsum seals, in flexible* and rigid walls minimum 100 mm thick .....	67

## **SPECIFIC PARTS OF THE EUROPEAN TECHNICAL ASSESSMENT**

### **1 Technical description of the product**

- 1) Tytan Professional B1 Fire Wrap is a pipe closure device used to form penetration seals where combustible pipes and insulated metal pipes penetrate walls and floors.
- 2) The Tytan Professional B1 Fire Wrap is supplied in Polyethylene bags size according to pipe diameter or supplied in single layer 25 metre rolls. The number of layers necessary are stated in Appendix 1. The wrap is wrapped around the pipe and pushed into the aperture in the separating element/ Tytan Professional B1 Fire Board or cast in with Tytan Professional B1 Fire Mortar Gypsum.
- 3) The applicant has submitted a written declaration that the product and/or constituents of the product contains no substances which have been classified as dangerous according to Directive 67/548/EEC and Regulation (EC) No. 1272/2008 and listed in the 'indicative list on dangerous substances' of the EGDS – taking into account the installation conditions of the construction product and the release scenarios resulting from there.

In addition to the specific clauses relating to dangerous substances contained in this European Technical Assessment, there may be other requirements applicable to the products falling within its scope (e.g. transposed European legislation and national laws, regulations and administrative provisions). In order to meet the provisions of the Construction Products Regulation, these requirements need also to be complied with, when and where they apply.

- 4) The use category of Tytan Professional B1 Fire Wrap in relation to BWR 3 (Hygiene, health and environment) is IA1, S/W3

**2 Specification of the intended uses of the product in accordance with the applicable European Assessment Document (Hereinafter EAD): EAD 350454-00-1104**

Detailed information and data is given in Annex A.

The intended use of system Tytan Professional B1 Fire Wrap is to reinstate the fire resistance performance of flexible wall and rigid wall and floor constructions, where they are penetrated by services.

- 1) The specific elements of construction that the system Tytan Professional B1 Fire Wrap may be used to provide a penetration seal in, are as follows:

Flexible walls: The wall must have a minimum thickness of 100 mm and comprise steel studs or timber studs\* lined on both faces with minimum 2 layers of 12.5 mm thick boards.

Rigid walls: The wall must have a minimum thickness of 100 mm and comprise concrete, aerated concrete or masonry, with a minimum density of 650 kg/m<sup>3</sup>.

Rigid floors: The floor must have a minimum thickness of 150 mm and comprise aerated concrete or concrete with a minimum density of 650 kg/m<sup>3</sup>.

\* no part of the penetration seal may be closer than 100 mm to a stud, the cavity must be closed between the penetration seal and the stud, and minimum 100 mm of insulation of class A1 or A2 according to EN 13501-1 must be provided within the cavity between the penetration seal and the stud.

The supporting construction must be classified in accordance with EN 13501-2 for the required fire resistance period.

- 2) Aperture sizes are given in Appendix A. Under EN 1366-3 rules, results from tests in floors with a penetration seal length of minimum 1000 mm apply to any length as long as the perimeter length to seal area ratio is not smaller than that of the tested penetration seal. The following aperture sizes are therefore allowed where 2400 mm x 1200 mm is described in floors:

Maximum Aperture Sizes within Floors or Between Floors and Walls
1200 mm width x 2400 mm length (tested)
1100 mm width x 2900 mm length
1000 mm width x 4000 mm length
900 mm width x 7000 mm length
≤800 mm width x ∞ (infinite) length

- 3) The system Tytan Professional B1 Fire Wrap may be used to provide a penetration seal with specific supporting constructions and substrates (for details see Annex A).
- 3) The provisions made in this European Technical Assessment are based on an assumed working life of the Tytan Professional B1 Fire Wrap of 25 years, provided that the conditions laid down in the manufacturers datasheet and instructions for the packaging/transport/storage/installation/use/repair are met. The indications given on the working life cannot be interpreted as a guarantee given by the producer or the Technical Assessment Body but are to be regarded only as a means for choosing the right products in relation to the expected economically reasonable working life of the works.
- 4) Type X: intended for use at conditions exposed to weathering.

**3 Performance of the product and references to the methods used for its assessment**

Product-type: Pipe Wrap	Intended use: Penetration Seal
Essential characteristic	Product Performance
<b>BWR 2 Safety in case of fire</b>	
Reaction to fire	No performance assessed
Resistance to fire	Annex A
<b>BWR 3 Hygiene, health and environment</b>	
Air permeability	No performance assessed
Water permeability	No performance assessed
Content, emission and/or release of dangerous substances	Use categories: IA1, S/W3 Declaration of manufacturer
<b>BWR 4 Safety in use</b>	
Mechanical resistance and stability	No performance assessed
Resistance to impact/movement	No performance assessed
Adhesion	No performance assessed
Durability	X
<b>BWR 5 Protection against noise</b>	
Airborne sound insulation	No performance assessed
<b>BWR 6 Energy economy and heat retention</b>	
Thermal properties	No performance assessed
Water vapour permeability	No performance assessed

**4 ASSESSMENT AND VERIFICATION OF CONSTANCY OF PERFORMANCE (HEREINAFTER AVCP) SYSTEM APPLIED, WITH REFERENCE TO ITS LEGAL BASE**

According to the decision 1999/454/EC – Commission Decision of date 22nd June 1999 on the procedure for attesting the conformity of construction products pursuant to Article 20(2) of Council Directive 89/106/EEC as regards fire stopping, fire sealing and fire protective products, published in the Official Journal of the European Union (OJEU) L178/52 of 14/07/1999, see <http://eur-lex.europa.eu/JOIndex.do> of the European Commission<sup>1</sup>, as amended, the system(s) of assessment and verification of constancy of performance (see Annex V to Regulation (EU) No 305/2011) given in the following table(s) applies (apply).

Product(s)	Intended use(s)	Level(s) or class(es)	System(s)
Fire stopping and Fire Sealing Products	For fire compartmentation and/or fire protection or fire performance	Any	1

**5 Technical details necessary for the implementation of the AVCP system, as provided for in the applicable EAD**

Technical details necessary for the implementation of the AVCP system are laid down in the control plan deposited at ETA-Danmark A/S prior to CE marking

Issued in Copenhagen on 2021-07-05 by

Thomas Bruun

Managing Director, ETA-Danmark

---

<sup>1</sup> Official Journal of the European Communities L178/52 of 14/7/1999



## ANNEX A – Resistance to Fire Classification – Tytan Professional B1 Fire Wrap

### A.1 Rigid wall constructions with wall thickness of minimum 150 mm

#### A.1.1 Tytan Professional B1 Fire Wrap penetration seals, in 100 mm thick Tytan Professional B1 Fire Mortar Gypsum seals in rigid walls with insulated metal pipes

**Penetration Seal:** CS (Continuous Sustained) insulated metallic pipes fitted at any position within the aperture (min. separation 10 mm from seal edges), with 100 mm Tytan Professional B1 Fire Mortar Gypsum to either side of the wall. Tytan Professional B1 Fire Wraps are required to be centrally within the seal for pipes with combustible insulation. Maximum seal size 2400 mm wide x 1200 mm high.

Construction details:

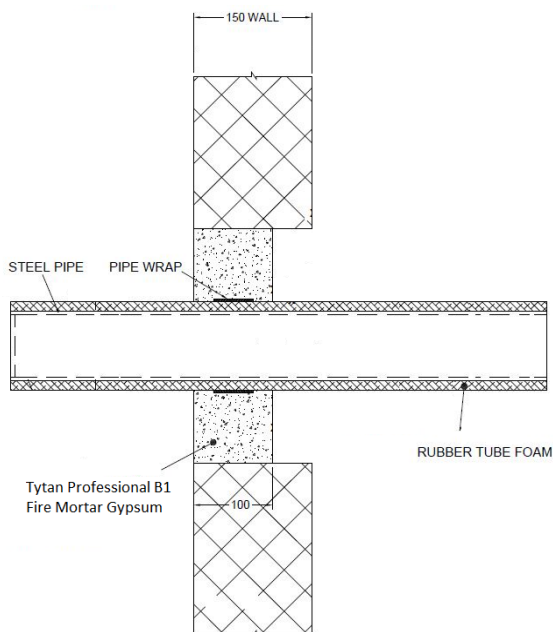

**A.1.1.1**

Services	Wrap	Insulation	Classification
Mild or stainless steel pipe			
40 mm diameter/1.5-14.2 mm wall	1 off 50 x 3.6mm Tytan Professional B1 Fire Wrap, fitted central	13 mm Elastomeric insulation minimum class B-s3,d0 or PE Foam insulation	<b>EI 240 C/U</b>
165 mm diameter/4.5-14.2 mm wall		9 mm Elastomeric insulation minimum class B-s3,d0 or PE Foam insulation	<b>E 240 C/U, EI 30 C/U</b>
40 mm diameter/1.5-14.2 mm wall*	1 off 50 x 1.8mm Tytan Professional B1 Fire Wrap, fitted central	13 -19 mm Elastomeric insulation minimum class B-s3,d0 or PE Foam insulation	<b>E 240 C/U, EI 60 C/U</b>
50 mm diameter/1.6-14.2 mm wall*			
60 mm diameter/1.7-14.2 mm wall*			
75 mm diameter/1.9-14.2 mm wall*			
90 mm diameter/2-14.2 mm wall*			
100 mm diameter/2.1-14.2 mm wall*			
115 mm diameter/2.3-14.2 mm wall*			
140 mm diameter/2.6-14.2 mm wall*			
165 mm diameter/2.8-14.2 mm wall*			

\* Typical pipe diameters shown, see below graph for intermediate sizes

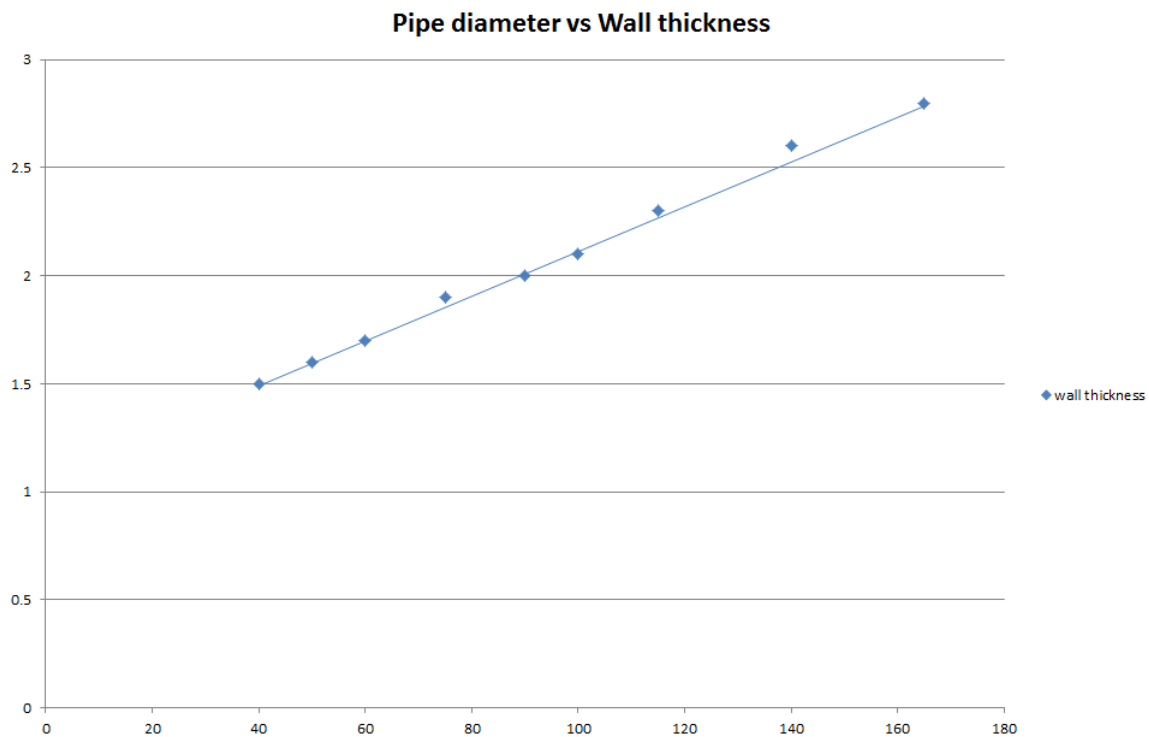

**A.1.1.2**

Services	Wrap	Insulation	Classification
Mild or stainless steel pipe			
40 mm diameter/1.5-14.2 mm wall*	1 off 50 x 3.6mm Tytan Professional B1 Fire Wrap, fitted central	13-25 mm Elastomeric insulation minimum class B-s3,d0 or PE Foam insulation	<b>E 180 C/U, EI 60 C/U</b>
50 mm diameter/1.8-14.2 mm wall*			
60 mm diameter/2-14.2 mm wall*			
75 mm diameter/2.3-14.2 mm wall*			
90 mm diameter/2.7-14.2 mm wall*			
100 mm diameter/2.9-14.2 mm wall*			
115 mm diameter/3.3-14.2 mm wall*			
140 mm diameter/3.9-14.2 mm wall*			
165 mm diameter/4.5-14.2 mm wall*			

\* Typical pipe diameters shown, see below graph for intermediate sizes

**Pipe diameter vs Wall thickness**

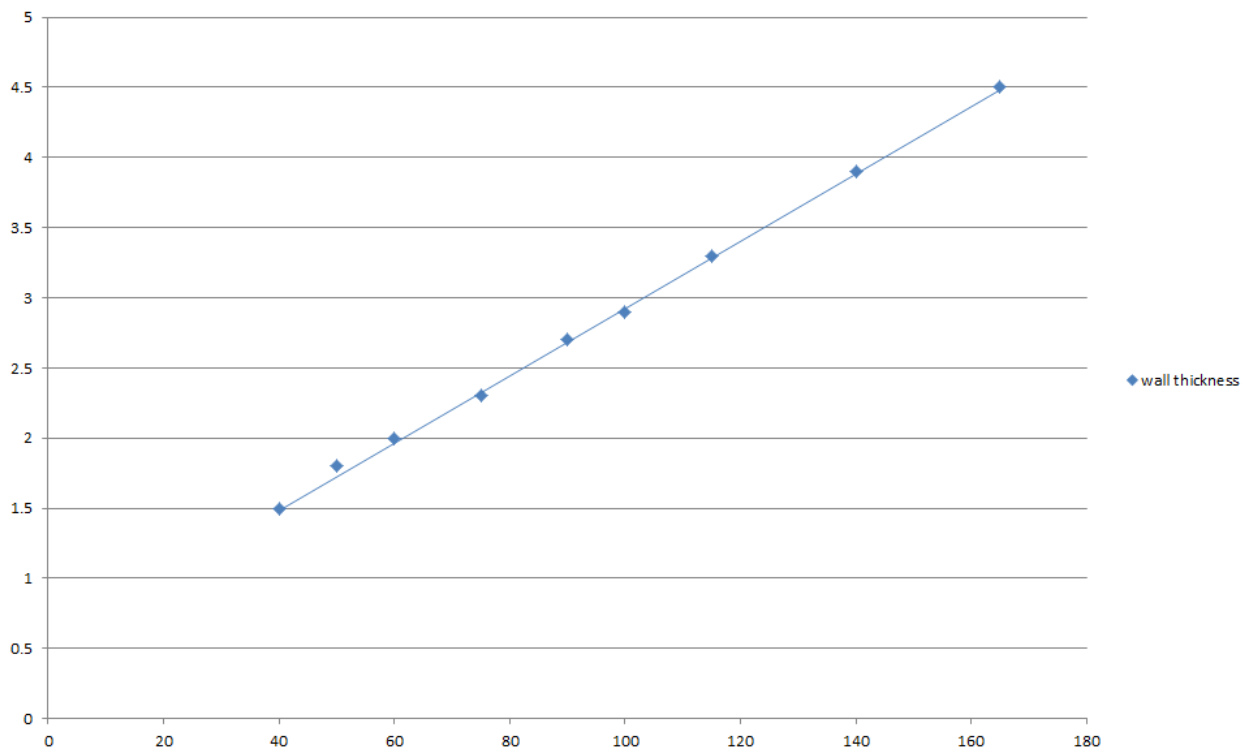

**A.1.2 Tytan Professional B1 Fire Wrap penetration seals, in 100 mm thick Tytan Professional B1 Fire Mortar Gypsum seals in rigid walls with plastic pipes**

**Penetration Seal:** plastic pipes fitted at any position within the aperture (min. separation 10 mm from seal edges), with 100 mm Tytan Professional B1 Fire Mortar Gypsum to either side of the wall. Tytan Professional B1 Fire Wraps are required to be centrally within the seal. Maximum seal size 2400 mm wide x 1200 mm high

Construction details:

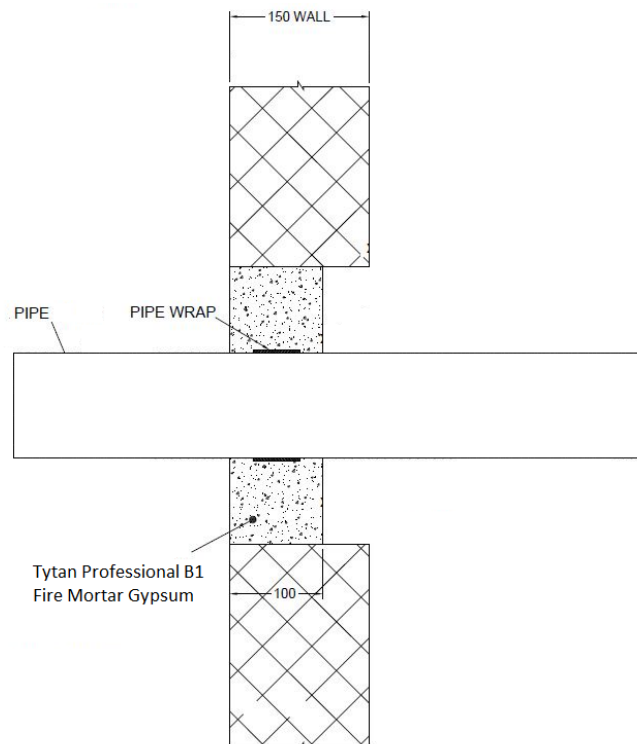

**A.1.2.1**

Services	Wrap	Insulation	Classification
PVC-U pipe according to EN 1329-1, EN 1452-1 and EN 1453-1 and PVC-C according to EN 1566-1			
315 mm diameter/9.2 mm wall	1 off 75 x 18 mm Tytan Professional B1 Fire Wrap, fitted central	None	EI 120 C/C

**A.2 Rigid floor constructions with a minimum thickness 150 mm**

**A.2.1 Tytan Professional B1 Fire Wrap penetration seals, in 100 mm thick Tytan Professional B1 Fire Mortar Gypsum seals in rigid floors, with insulated metal pipes**

**Penetration Seal:** CS (Continuous Sustained) insulated metallic pipes fitted at any position within the aperture (min. separation 25 mm from seal edges and 30 mm from other services), with 100 mm Tytan Professional B1 Fire Mortar Gypsum at any position within the floor. Tytan Professional B1 Fire Wraps are required to be fitted around combustible pipe insulation. Maximum seal size 1200 x 2400 mm.

Construction details:

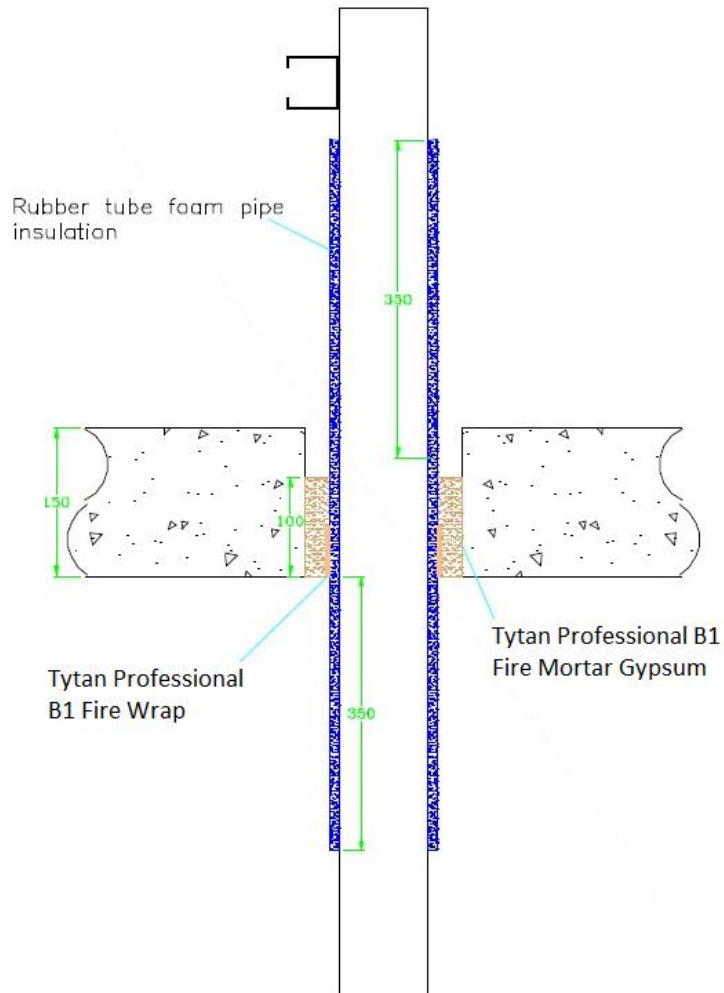

**A.2.1.1**

<b>Services</b>	<b>Wrap</b>	<b>Insulation</b>	<b>Classification</b>
Copper pipe			
12 mm diameter/1 mm wall	50 x 3.6 mm Tytan Professional B1 Fire Wrap fitted to the soffit	9 mm Elastomeric insulation minimum class B-s3,d0 or foil faced Phenolic Foam insulation	<b>EI 240 C/C</b>
12-54 mm diameter/1-1.2 mm wall		13-25 mm Elastomeric insulation minimum class B-s3,d0 or foil faced Phenolic Foam insulation	<b>E 240 C/C, EI 60 C/C</b>
<b>Geberit Mepla MLC (PE-Xb/Aluminium/PE-HD pipe)</b>			
16 mm diameter/2.25 mm wall	50 x 3.6 mm Tytan Professional B1 Fire Wrap fitted to the soffit	9 mm Elastomeric insulation minimum class B-s3,d0 or foil faced Phenolic Foam insulation	<b>EI 240 C/C</b>
16 mm diameter/2.25 mm wall		9-13 mm Elastomeric insulation minimum class B-s3,d0 or foil faced Phenolic Foam insulation	<b>E 240 C/C, EI 90 C/C</b>
20 mm diameter/2.5 mm wall			
26 mm diameter/3 mm wall			
32 mm diameter/3 mm wall			
40 mm diameter/3.5 mm wall			
50 mm diameter/4 mm wall			
63 mm diameter/4.5 mm wall		13-25 mm Elastomeric insulation minimum class B-s3,d0 or foil faced Phenolic Foam insulation	<b>E 180 C/C, EI 90 C/C</b>
75 mm diameter/4.7 mm wall			
16 mm diameter/2.25 mm wall			
20 mm diameter/2.5 mm wall			
26 mm diameter/3 mm wall			
32 mm diameter/3 mm wall			
40 mm diameter/3.5 mm wall			
50 mm diameter/4 mm wall			
63 mm diameter/4.5 mm wall			
75 mm diameter/4.7 mm wall			

### A.2.2 Tytan Professional B1 Fire Wrap penetration seals, in 100 mm thick Tytan Professional B1 Fire Mortar Gypsum seals in rigid floors, with insulated metal pipes

**Penetration Seal:** CS (Continuous Sustained) insulated metallic pipes fitted at any position within the aperture (min. separation 30 mm from seal edges and 30 mm from other services), with 100 mm Tytan Professional B1 Fire Mortar Gypsum to the top surface of the floor. Tytan Professional B1 Fire Wraps are required to be fitted around combustible pipe insulation. Maximum seal size 2400 mm x 1200 mm.

Construction details:

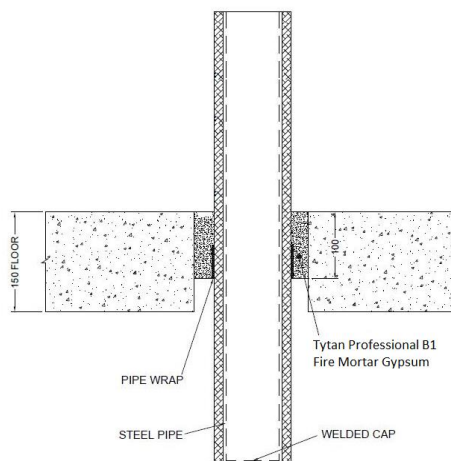

#### A.2.2.1

Services	Wrap	Insulation	Classification
Mild or stainless steel pipe 40 mm diameter/-14.2 mm wall	1 off 50 x 1.8 mm Tytan Professional B1 Fire Wrap, fitted at soffit	13 mm Elastomeric insulation minimum class B-s3,d0 or foil faced Phenolic Foam insulation	<b>EI 180 C/U</b>
40 mm diameter/1.5-14.2 mm wall*		13 -19 mm Elastomeric insulation minimum class B-s3,d0 or foil faced Phenolic Foam insulation	
50 mm diameter/1.6-14.2 mm wall*			
60 mm diameter/1.7-14.2 mm wall*			
75 mm diameter/1.9-14.2 mm wall*			
90 mm diameter/2-14.2 mm wall*			
100 mm diameter/2.1-14.2 mm wall*			
115 mm diameter/2.3-14.2 mm wall*			
140 mm diameter/2.6-14.2 mm wall*			
165 mm diameter/2.8-14.2 mm wall*			

\* Typical pipe diameters shown, see below graph for intermediate sizes

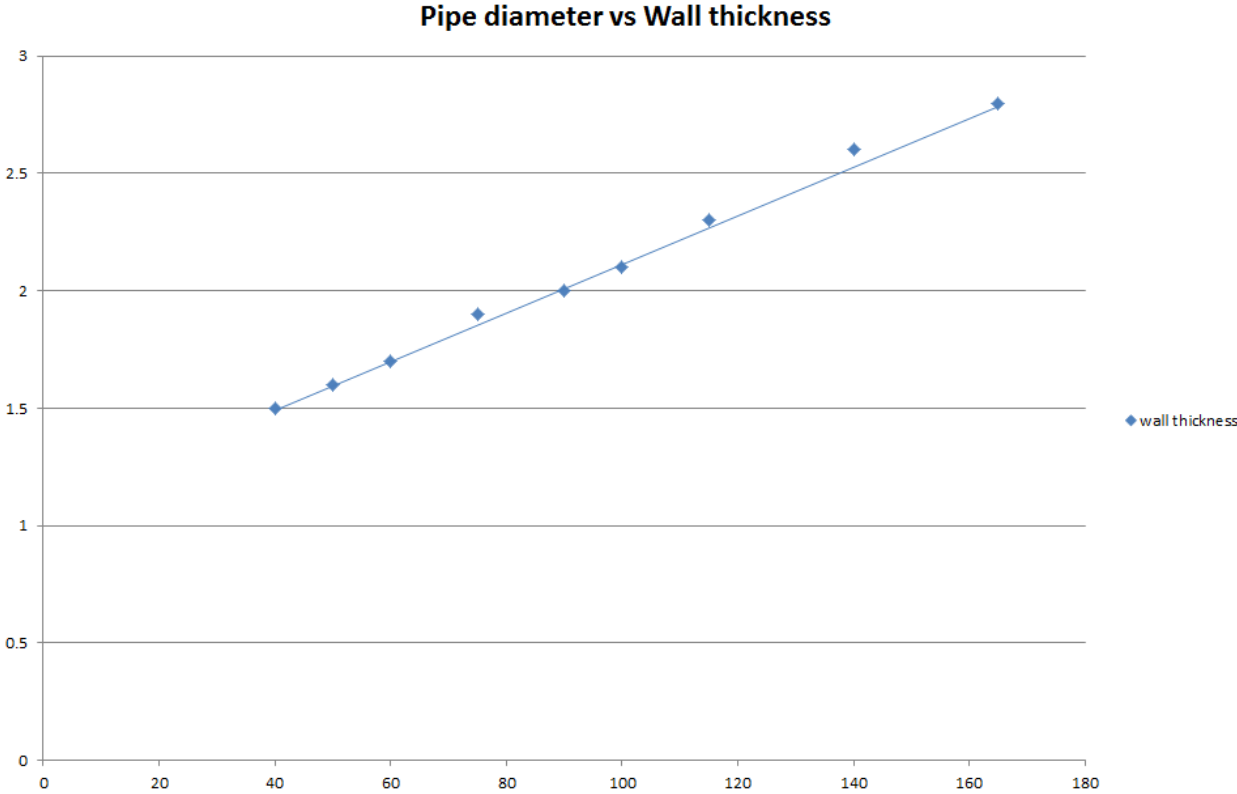



### A.2.3 Tytan Professional B1 Fire Wrap penetration seal for insulated metal pipes, in Tytan Professional B1 Fire Mortar Gypsum Seal, in rigid floors

**Penetration Seal:** CS (Continuous Sustained) insulated metallic pipes sealed with Tytan Professional B1 Fire Wraps, fitted at any position within the aperture, with 100 mm Tytan Professional B1 Fire Mortar Gypsum Seal. Minimum separation between penetration seals and seal edges of 30 mm (Configuration 1 & 2).

Construction details:

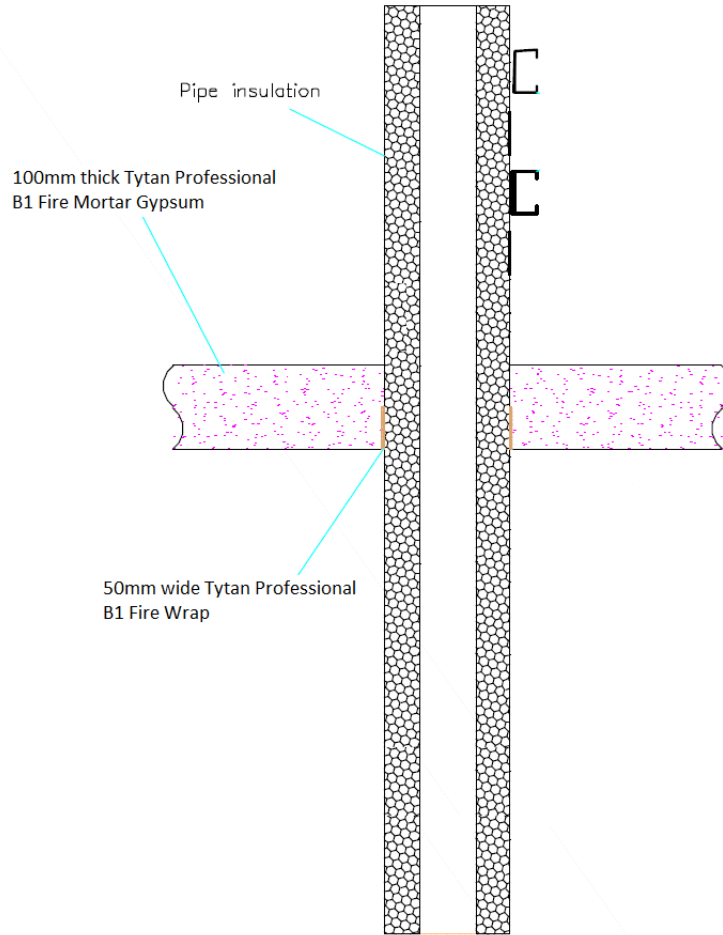

**Configuration 1**

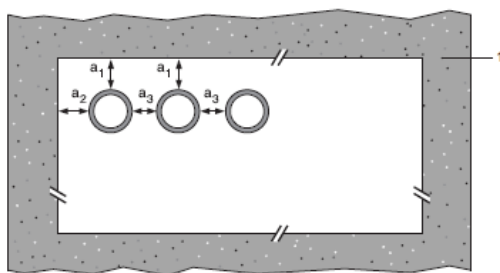

**Configuration 2**

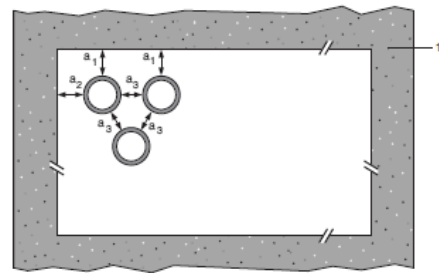

**Key**

- 1 Supporting construction
- a1 Pipe / top edge of seal separation
- a2 Pipe / side edge of seal separation
- a3 Pipe / pipe separation

## A.2.3.1

Mild or stainless steel pipe	Insulation	Tytan Professional B1 Fire Wrap	Classification
40 mm diameter/1-14.2 mm wall	25 mm thick Elastomeric insulation minimum class B-s3,d0 or foil faced Phenolic Foam insulation	50 x 3.6 mm (2 x 1.8 layer)	EI 240 C/U
40 mm diameter/1-14.2 mm wall*	25mm thick Elastomeric insulation minimum class B-s3,d0 or foil faced Phenolic Foam insulation		E 240 C/U EI 120 C/U
50 mm diameter/1.2-14.2 mm wall*			
60 mm diameter/1.4-14.2 mm wall*			
75 mm diameter/1.6-14.2 mm wall*			
90 mm diameter/1.9-14.2 mm wall*			
100 mm diameter/2.1-14.2 mm wall*			
115 mm diameter/2.4-14.2 mm wall*			
140 mm diameter/2.9-14.2 mm wall*			
165 mm diameter/ 3.4-14.2 mm wall*			
180 mm diameter/ 3.6-14.2 mm wall*			
200 mm diameter/ 4.0-14.2 mm wall*			
219 mm diameter/ 4.3-14.2 mm wall*			
250 mm diameter/ 5.0-14.2 mm wall*			
300 mm diameter/ 5.9-14.2 mm wall*			
324 mm diameter/ 6.35-14.2 mm wall*	25-50mm thick Elastomeric insulation minimum class B-s3,d0 or foil faced Phenolic Foam insulation	50 x 5.4 mm (3 x 1.8 layer)	EI 120 C/U
40 mm diameter/1-14.2 mm wall*			
50 mm diameter/1.2-14.2 mm wall*			
60 mm diameter/1.4-14.2 mm wall*			
75 mm diameter/1.6-14.2 mm wall*			
90 mm diameter/1.9-14.2 mm wall*			
100 mm diameter/2.1-14.2 mm wall*			
115 mm diameter/2.4-14.2 mm wall*			
140 mm diameter/2.9-14.2 mm wall*			
165 mm diameter/ 3.4-14.2 mm wall*			
180 mm diameter/ 3.6-14.2 mm wall*			
200 mm diameter/ 4.0-14.2 mm wall*			
219 mm diameter/ 4.3-14.2 mm wall*			
250 mm diameter/ 5.0-14.2 mm wall*			
300 mm diameter/ 5.9-14.2 mm wall*			
324 mm diameter/ 6.35-14.2 mm wall*			

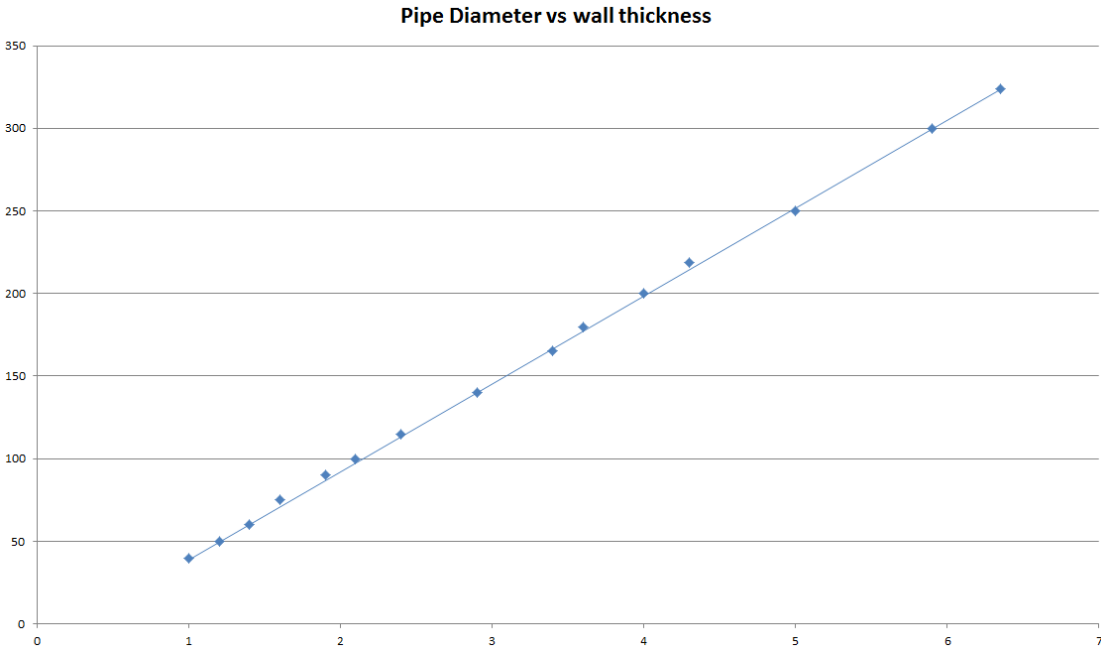

#### A.2.4 Tytan Professional B1 Fire Wrap penetration seals, in 100 mm deep Tytan Professional B1 Fire Mortar Gypsum seals in rigid floors, with plastic pipes

**Penetration Seal:** Plastic pipes fitted at any position within the aperture, with 100 mm Tytan Professional B1 Fire Mortar Gypsum to the either surface of the floor or anywhere between. Tytan Professional B1 Fire Wraps are required to be fitted to the bottom of the seal, as indicated below. Minimum separation between penetration seals and seal edges of 30 mm (Configuration 1 & 2).

Construction details:

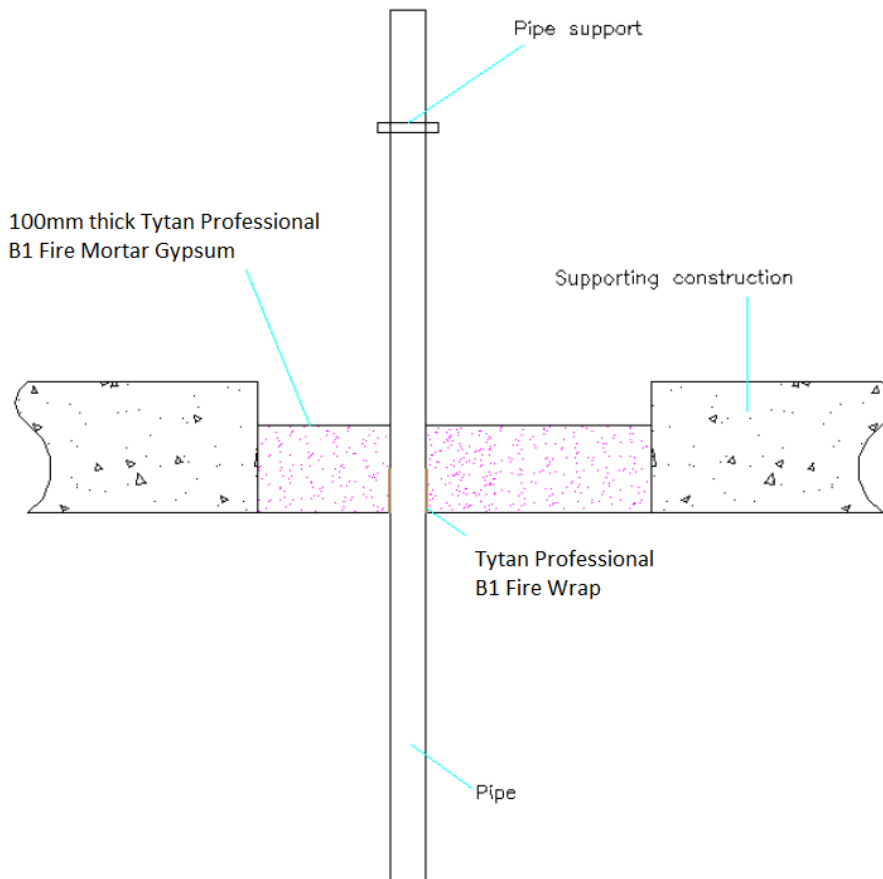

## A.2.4.1

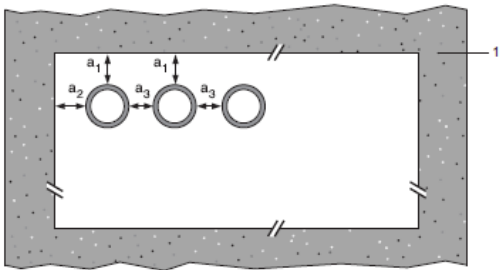
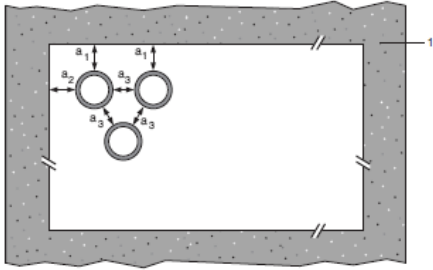
Services	Wrap	Maximum aperture	Classification
<b>PVC-U pipe according to EN 1329-1, EN 1452-1 and EN 1453-1, PVC-C according to EN 1566-1</b>			
Up to 40 mm diameter / 1.8-3.7 mm wall	50 x 1.8 mm	2400 x 1200 mm	<b>E 180 U/U, EI 120 U/U</b>
Up to 110 mm diameter / 3.0-6.6 mm wall	50 x 3.6 mm		<b>EI 240 U/C</b>
Up to 125 mm diameter / 3.5-7.4 mm wall	50 x 7.2 mm		<b>EI 120 U/C</b>
Up to 160 mm diameter / 4.5 mm wall	50 x 10.8 mm		<b>EI 240 C/C</b>
Up to 160 mm diameter / 4.5-9.5 mm wall	50 x 10.8 mm		<b>EI 90 C/C</b>
Up to 110 mm diameter/ 2.7-6.6 mm wall, containing up to 90mm $\varnothing$ bundle of up to 14 mm $\varnothing$ telecom cables	50 x 3.6 mm		<b>EI 120 U/C</b>
<b>PP pipe according to EN 1451-1</b>			
Up to 40 mm diameter /1.8-4.4 mm wall	None	2400 x 1200 mm	<b>EI 120 U/C</b>
Up to 40 mm diameter /1.8-5.5 mm wall	50 x 1.8 mm		<b>EI 120 U/U</b>
Up to 50 mm diameter /2.5-5.5 mm wall	50 x 3.6 mm		<b>EI 240 C/C</b>
Up to 75 mm diameter /3.5-5.5 mm wall	50 x 3.6 mm		<b>EI 240 C/C</b>
Up to 110 mm diameter /2.7-6.3 mm wall	50 x 3.6 mm		<b>EI 240 U/C</b>
Up to 125 mm diameter /3.4-11.4 mm wall	50 x 7.2 mm		<b>EI 240 U/C</b>
Up to 160 mm diameter /4.9-14.6 mm wall	50 x 10.8 mm		<b>EI 240 U/C</b>
Up to 110 mm diameter/ 3.4-6.3 mm wall, containing up to 90mm $\varnothing$ bundle of up to 14 mm $\varnothing$ telecom cables	50 x 3.6 mm		<b>EI 60 U/C</b>
<b>PE pipe according to EN 1519-1, EN 12201-2 and EN 12666-1, ABS according to EN 1455-1 and pipes made from SAN+PVC according to EN 1565-1</b>			
Up to 40 mm diameter / 2.0-4.4 mm wall	None	2400 x 1200 mm	<b>EI 120 U/C</b>
Up to 40 mm diameter / 2.4-3.7 mm wall	50 x 1.8 mm		<b>EI 240 U/U</b>
Up to 110 mm diameter / 3.4-10.0 mm wall	50 x 3.6 mm		<b>EI 120 U/C</b>
Up to 125 mm diameter / 3.9-11.4 mm wall	50 x 7.2 mm		<b>EI 240 U/C</b>
Up to 160 mm diameter / 4.9-14.6 mm wall	50 x 10.8 mm		<b>EI 120 U/C</b>
Up to 250 mm diameter / 7.8 mm wall	75 x 12.6 mm		<b>EI 180 C/C</b>
Up to 110 mm diameter/ 2.7-10.0 mm wall, containing up to 90mm $\varnothing$ bundle of up to 14 mm $\varnothing$ telecom cables	50 x 3.6 mm		<b>E 120 U/C, EI 60 U/C</b>
<b>Configuration 1</b>		<b>Configuration 2</b>	
			
<b>Key</b>			
1 Supporting construction			
a1 Pipe / top edge of seal separation			
a2 Pipe / side edge of seal separation			
a3 Pipe / pipe separation			

### PVC-U Pipes U/C with Tytan Professional B1 Fire Wrap – EI 120 U/V

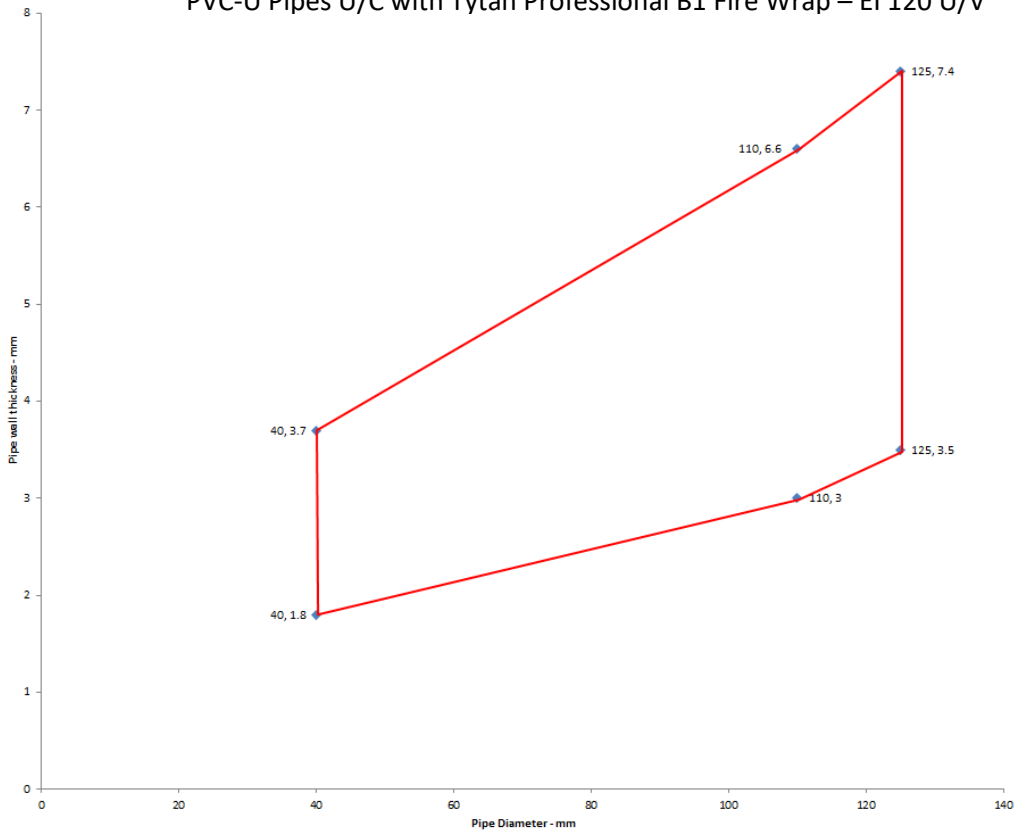

### PE Pipes U/C with Tytan Professional B1 Fire Wrap – EI 120

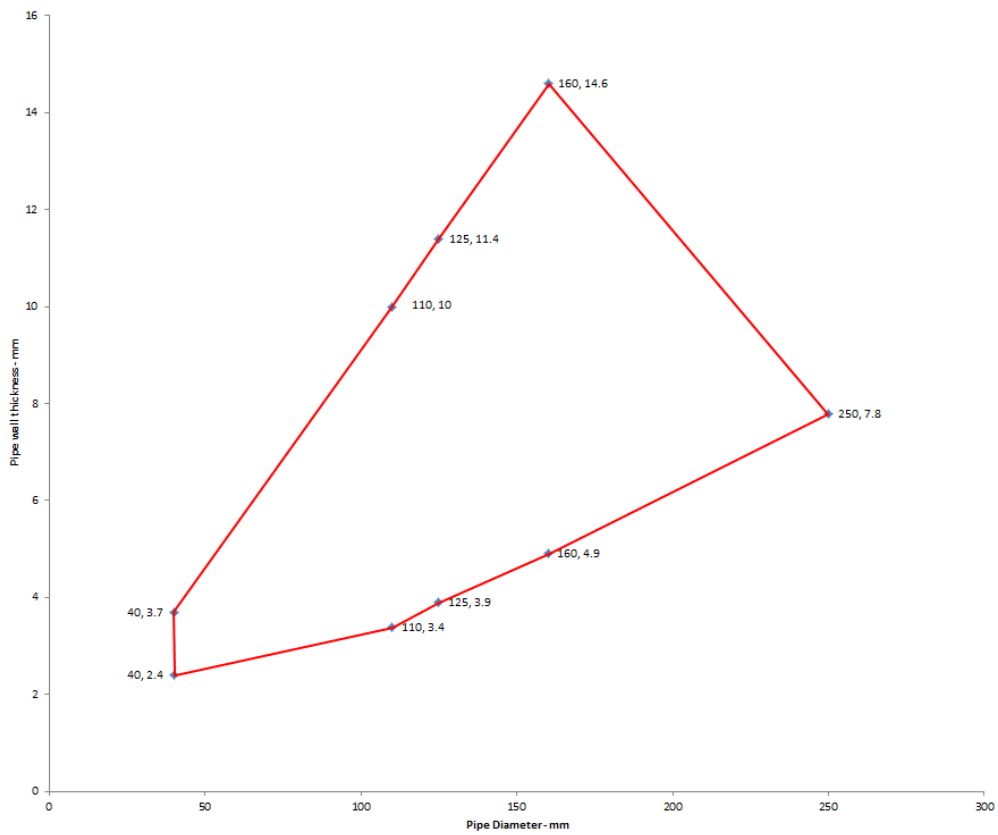

### PP Pipes U/C with Tytan Professional B1 Fire Wrap – EI 120

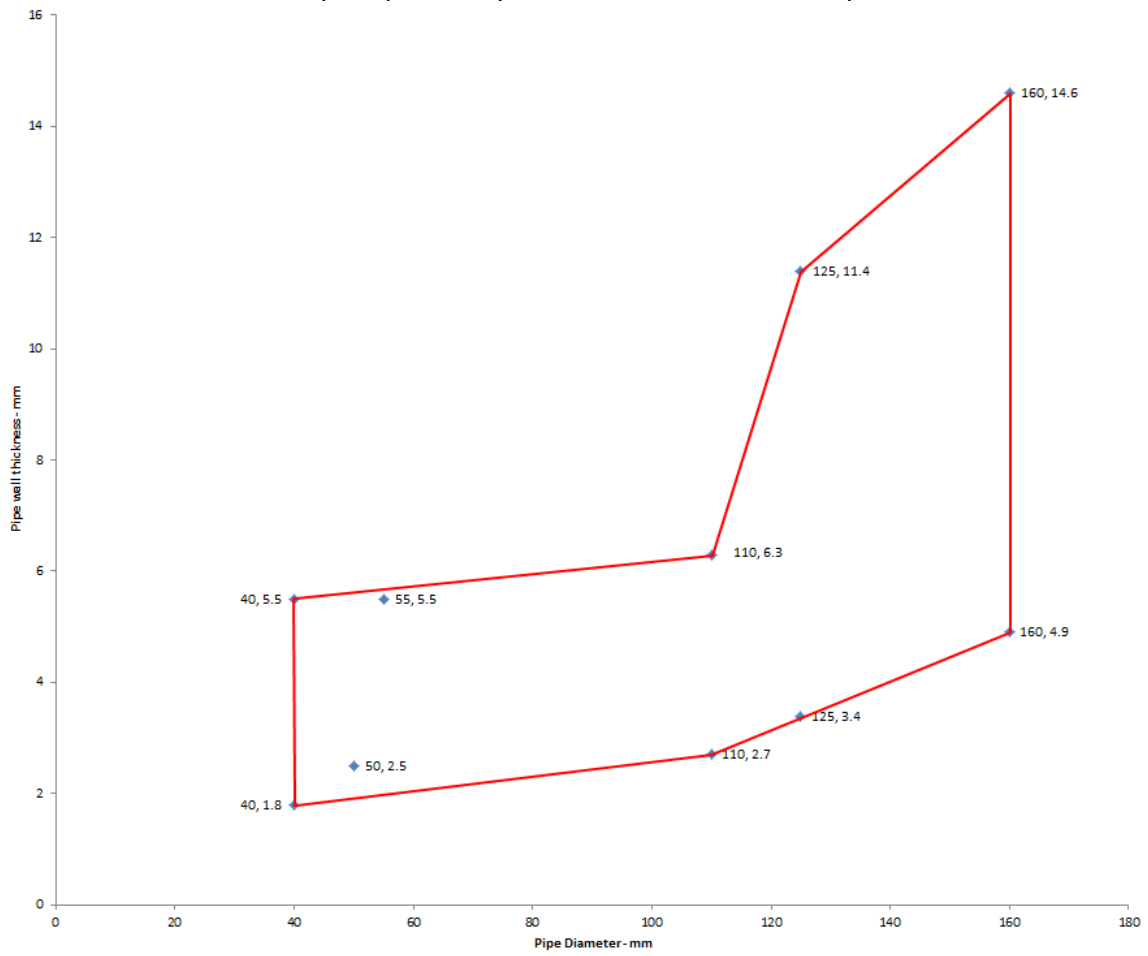

### A.2.5 Tytan Professional B1 Fire Wrap penetration seals, in 100 mm thick Tytan Professional B1 Fire Mortar Gypsum seals in rigid floors, with plastic pipes

<p><b>Penetration Seal:</b> Plastic pipes fitted at any position within the aperture (min. separation 30 mm from seal edges and from other services), with 100 mm Tytan Professional B1 Fire Mortar Gypsum to the bottom surface of the floor. Tytan Professional B1 Fire Wraps are required to be fitted to the bottom of the seal, as indicated below. Maximum seal size 2400 mm x 1200 mm.</p>	
<p><b>Construction details:</b></p>	
<p><b>Configuration 1</b></p>	<p><b>Configuration 2</b></p>
<p><b>Key</b></p> <ul style="list-style-type: none"> <li>1 Supporting construction</li> <li>a1 Pipe / top edge of seal separation</li> <li>a2 Pipe / side edge of seal separation</li> <li>a3 Pipe / pipe separation</li> </ul>	



## A.2.5.1

Services	Wrap	Permitted configuration for seal separation	Classification
PVC-U pipe according to EN 1329-1, EN 1452-1 and EN 1453-1, PVC-C according to EN 1566-1			
160 mm diameter / 9.5 mm wall	50 x 10.8 mm (6 x 1.8 layers)	1 & 2	EI 90 U/C
Uponor Wirsbo PEX pipe in pipe system according to ISO 15875			
Maximum 54 mm diameter/0.4 mm wall thickness (outer pipe), 28 mm diameter/4.0 mm wall thickness (inner pipe)	50 x 3.6 mm (2 x 1.8 layers)	1 & 2	EI 120 C/C
Rehau Raupiano Plus PP-DD according to DIN 4102			
40-50 mm diameter/1.8-2.7 mm wall thickness*	50 x 3.6 mm (2 x 1.8 layers)	1 & 2	EI 120 U/U
75-110 mm diameter/2.7 mm wall thickness*	50 x 3.6 mm (2 x 1.8 layers)	1 & 2	EI 120 U/C
125 mm diameter/3.1 mm wall thickness	50 x 7.2 mm (4 x 1.8 layers)	1 & 2	E 240 U/C, EI 120 U/C
160 mm diameter/3.9 mm wall thickness	50 x 10.8 mm (6 x 1.8 layers)	1 & 2	EI 120 U/C
Polo-Kal NG Poloplast PP-MV according to DIN 4102			
32-110 mm diameter/3.4 mm wall thickness	50 x 3.6 mm (2 x 1.8 layers)	1 & 2	EI 180 U/C
125 mm diameter/3.9 mm wall thickness	50 x 7.2 mm (4 x 1.8 layers)	1 & 2	EI 240 U/C
160 mm diameter/4.3 mm wall thickness	50 x 10.8 mm (6 x 1.8 layers)	1 & 2	EI 240 U/C
Aquatherm Green SDR9 MF PP-RP according to ISO 21003			
32 mm diameter/3.6 mm wall thickness	50 x 1.8 mm (1 x 1.8 layer)	1 & 2	EI 240 C/C
40-50 mm diameter/5.6-12.3 mm wall thickness*	50 x 3.6 mm (2 x 1.8 layers)	1 & 2	EI 240 C/C
63-110 mm diameter/12.3 mm wall thickness*	50 x 3.6 mm (2 x 1.8 layers)	1 & 2	EI 240 C/C
Wavin SiTech + PP-M B according to EN 13501-1			
32-50 mm diameter/1.8-3.4 mm wall thickness*	50 x 3.6 mm (2 x 1.8 layers)	1 & 2	EI 120 U/U
75-110 mm diameter/3.4 mm wall thickness*	50 x 3.6 mm (2 x 1.8 layers)	1 & 2	EI 120 U/C
Geberit Silent PP according to DIN 4102			
32-50 mm diameter/1.8-3.4 mm wall thickness*	50 x 3.6 mm (2 x 1.8 layers)	1 & 2	EI 120 U/U
75-110 mm diameter/3.4 mm wall thickness*	50 x 3.6 mm (2 x 1.8 layers)	1 & 2	EI 120 U/C

\* Typical pipe diameters shown, see below graph for intermediate sizes

### Rehau Raupiano Plus -EI 120 U/U

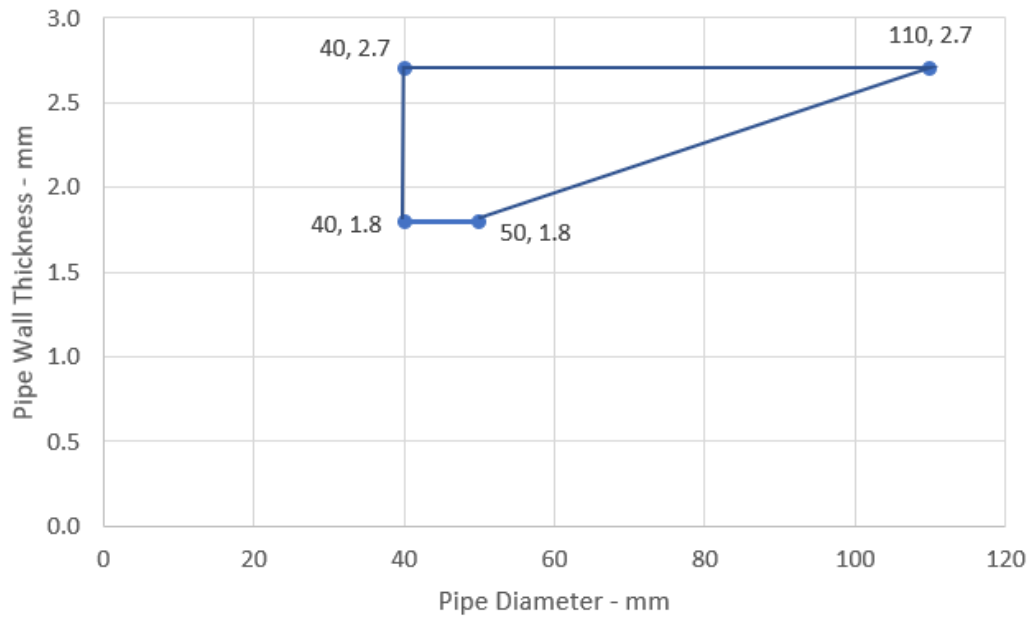

### Aquatherm Green - EI 240 C/C

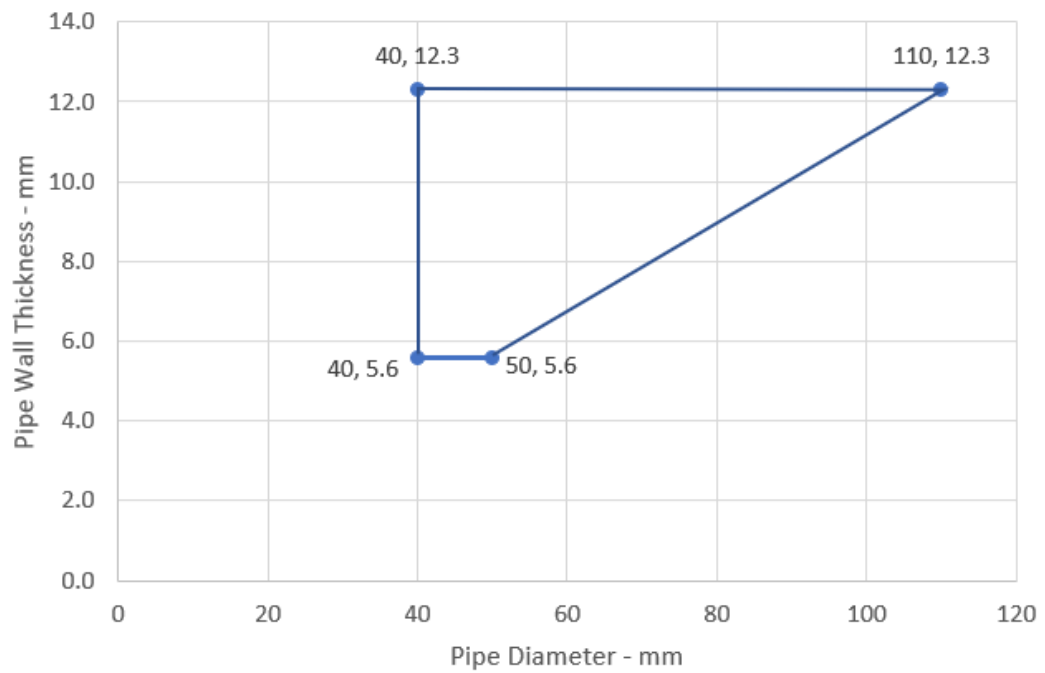

### Wavin SiTech Pipes - EI 120 U/C

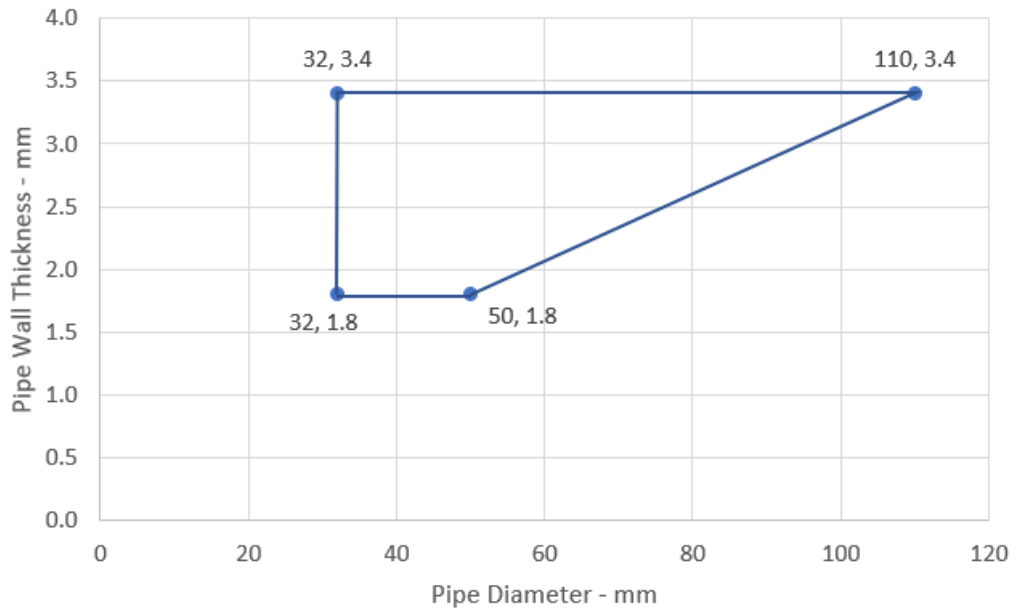

### Gilbert Silent PP - EI 120 U/C

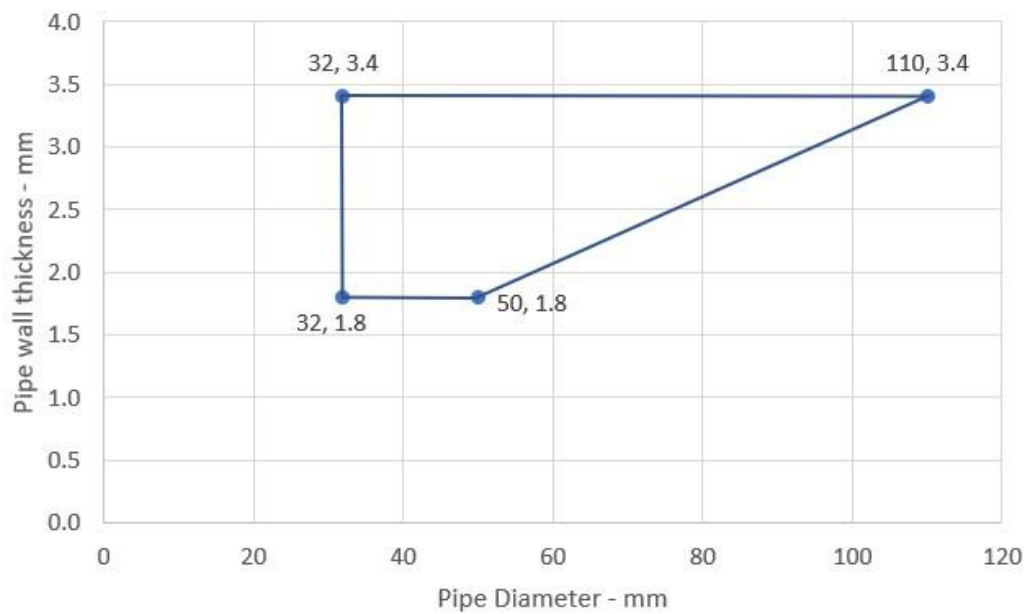

### A.2.6 Tytan Professional B1 Fire Wrap penetration seals, in Tytan Professional B1 Fire Mortar Gypsum seals in rigid floors, with plastic pipes

**Penetration Seal:** Plastic pipes fitted at any position within the aperture (min. separation 30 mm from seal edges and from other services), with Tytan Professional B1 Fire Mortar Gypsum to the bottom surface of the floor. Tytan Professional B1 Fire Wraps are required to be fitted to the bottom of the seal, as indicated below. Maximum seal size 2400 mm x 1200 mm.

Construction details:

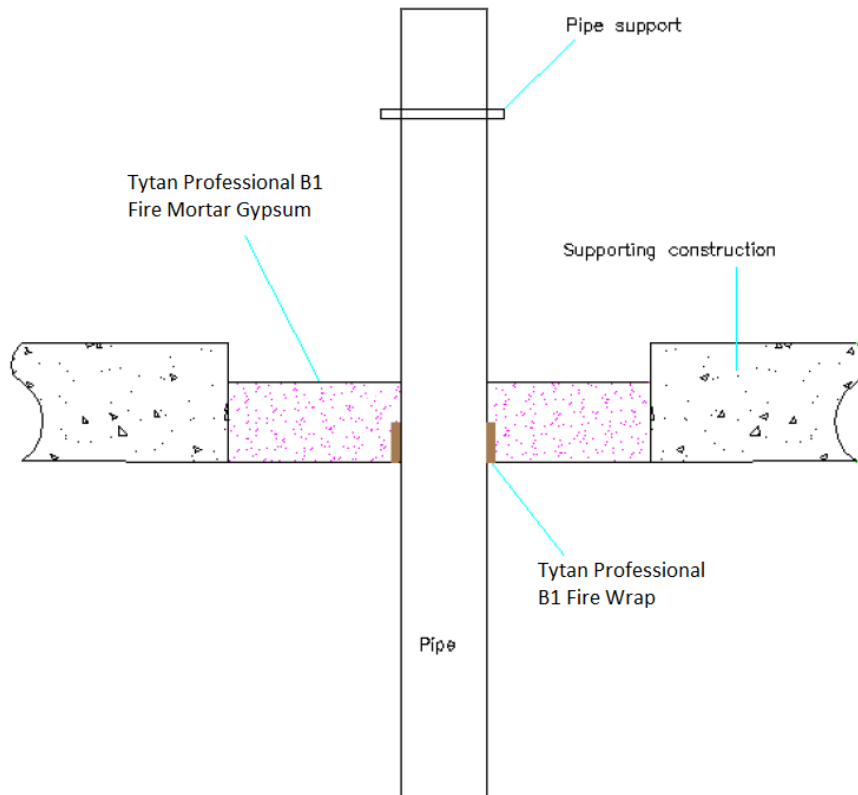

**Configuration 1**

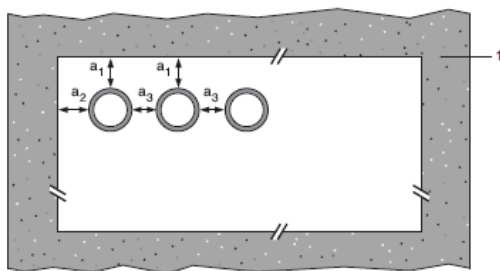

**Configuration 2**

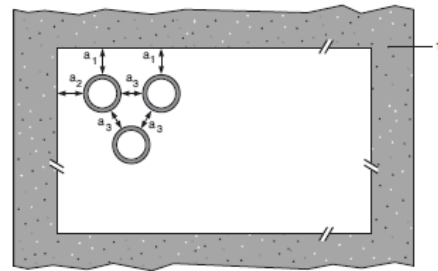

**Key**

- 1 Supporting construction
- a1 Pipe / top edge of seal separation
- a2 Pipe / side edge of seal separation
- a3 Pipe / pipe separation

## A.2.6.1

Services	Wrap	Permitted configuration for seal separation	Mortar depth	Classification
<b>PVC-U pipe according to EN 1329-1, EN 1452-1 and EN 1453-1, PVC-C according to EN 1566-1</b>				
Diameter 41 mm, wall thickness 1.8-3.7 mm to diameter 125 mm, wall thickness 4.8-7.4 mm*	50 x 7.2 mm (4 x 1.8 layers)	1 & 2	150 mm	EI 60 U/U
125 mm diameter / 7.4 mm wall	50 x 7.2 mm (4 x 1.8 layers)	1 & 2	150 mm	EI 120 U/U
Diameter 126 mm, wall thickness 4.8-7.4 mm to diameter 160 mm, wall thickness 9.5 mm*	75 x 10.8 mm (6 x 1.8 layers)	1	150 mm	E 120 U/U, EI 30 U/U
160 mm diameter / 9.5 mm wall	75 x 7.2 mm (4 x 1.8 layers)	1	150 mm	E 120 U/U, EI 30 U/U
160 mm diameter / 4.5-9.5 mm wall thickness	50 x 10.8 mm (6 x 1.8 layers)	1 & 2	120 mm	EI 120 U/C, EI 120 C/C
315 mm diameter / 7.7 mm wall thickness	75 x 18 mm (10 x 1.8 layers)	1	120 mm	EI 120 C/C
Diameter 161 mm, wall thickness 4.5-9.5 mm to diameter 315 mm, wall thickness 7.7-12.1 mm*	75 x 18 mm (10 x 1.8 layers)	1	120 mm	EI 90 C/C
315 mm diameter / 12.1 mm wall thickness	75 x 18 mm (10 x 1.8 layers)	1	120 mm	EI 90 C/C
<b>PP pipe according to EN 1451-1</b>				
Diameter 41 mm, wall thickness 1.8-5.5 mm to diameter 160 mm, wall thickness 4.9-14.6 mm*	75 x 10.8 mm (6 x 1.8 layers)	1 & 2	150 mm	EI 120 U/C
160 mm diameter / 14.6 mm wall	75 x 7.2 mm (4 x 1.8 layers)	1 & 2	150 mm	EI 240 U/U
Diameter 161 mm, wall thickness 4.9-14.6 mm to diameter 200 mm, wall thickness 4.9-18.2 mm*	75 x 10.8 mm (6 x 1.8 layers)	1 & 2	120 mm	EI 240 C/C
Diameter 201 mm, wall thickness 4.9-18.2 mm to diameter 315 mm, wall thickness 7.7-28.6 mm*	75 x 18 mm (10 x 1.8 layers)	N/A	150 mm	EI 60 C/C
315 mm diameter / 7.7 mm wall	75 x 18 mm (10 x 1.8 layers)	N/A	150 mm	EI 180 C/C
315 mm diameter / 7.7-28.6 mm wall	75 x 18 mm (10 x 1.8 layers)	1	150 mm	EI 60 C/C

Services	Wrap	Permitted configuration for seal separation	Mortar depth	Classification
<b>PE pipe according to EN 1519-1, EN 12201-2 and EN 12666-1, ABS according to EN 1455-1 and pipes made from SAN+PVC according to EN 1565-1</b>				
Diameter 126 mm, wall thickness 3.9-11.4 mm to diameter 160 mm, wall thickness 14.6*	75 x 18 mm (10 x 1.8 layers)	N/A	150 mm	<b>E 240 U/U, EI 120 U/U</b>
160 mm diameter / 14.6 mm wall	75 x 7.2 mm (4 x 1.8 layers)	1 & 2	150 mm	<b>E 240 U/U, EI 120 U/U</b>
Diameter 161 mm, wall thickness 4.9-14.6 mm to diameter 315 mm, wall thickness 9.7-18.7 mm*	75 x 18 mm (10 x 1.8 layers)	N/A	150 mm	<b>EI 60 C/C</b>

\* Typical pipe diameters shown, see below graph for intermediate sizes

### PVC-U Pipes 41-125 mm Diameter - EI 60 U/U

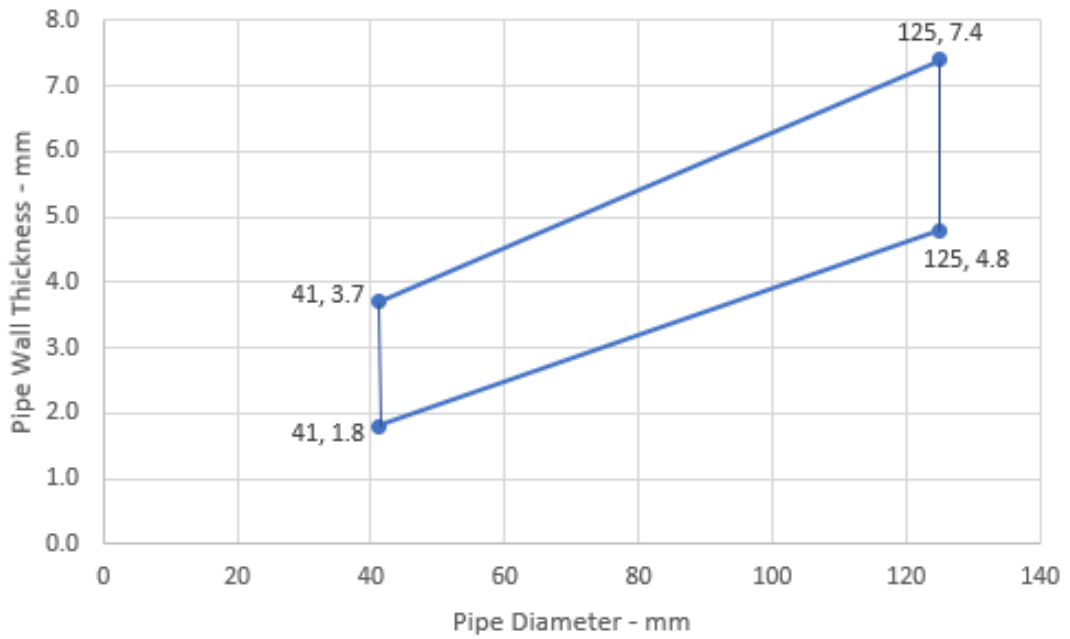

### PVC-U Pipes 126-160 mm Diameter - E 120 U/U, EI 30 U/U

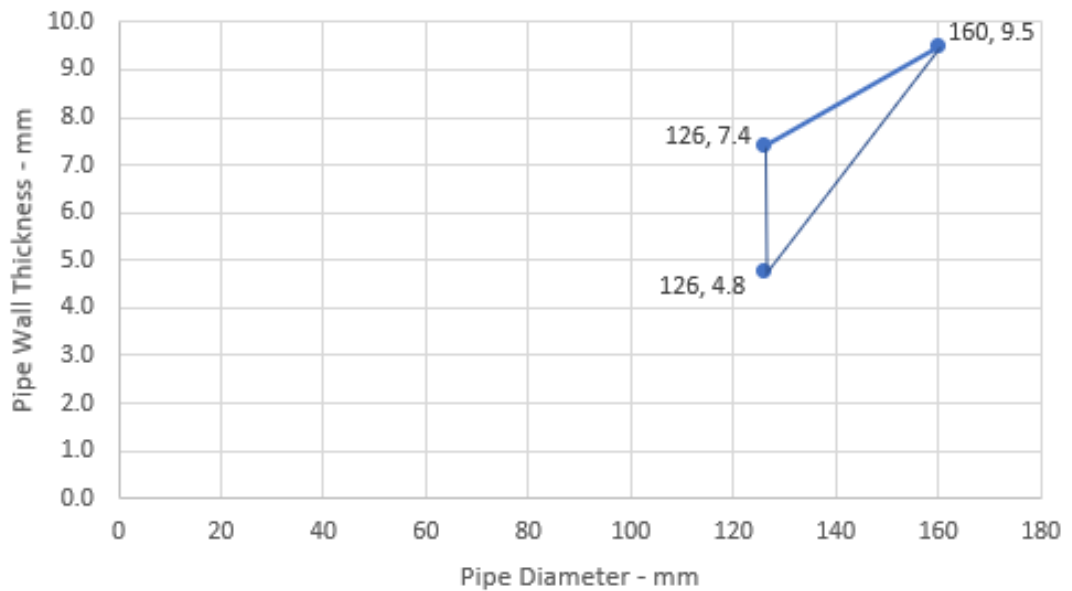

### PVC-U Pipes - EI 90 C/C

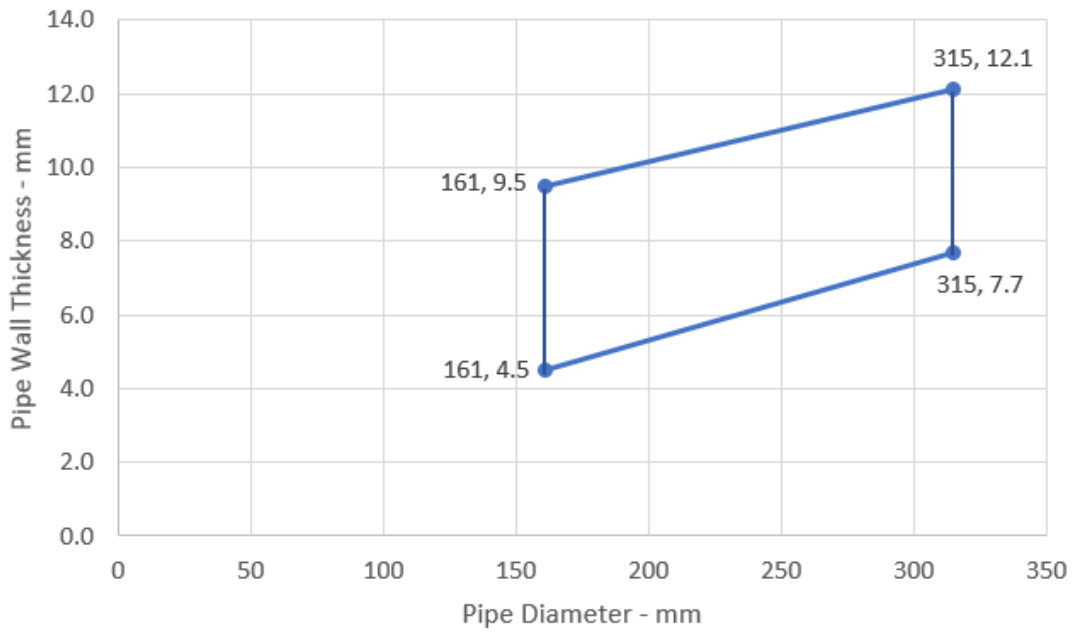

### PP Pipes 41-160 mm Diameter - EI 120 U/C

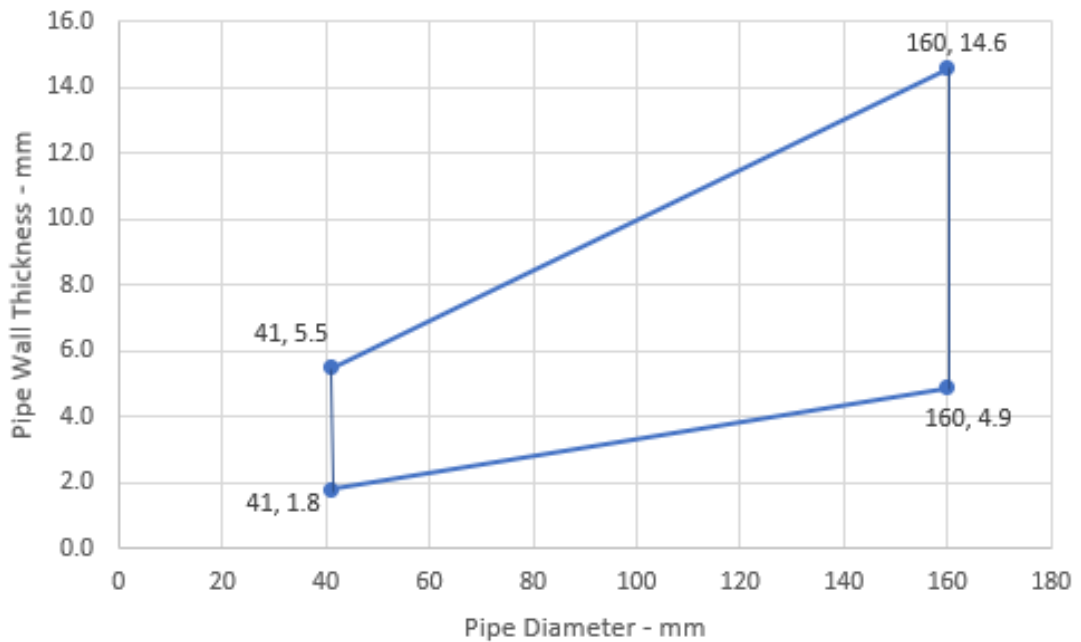



### PP Pipes - EI 240 C/C

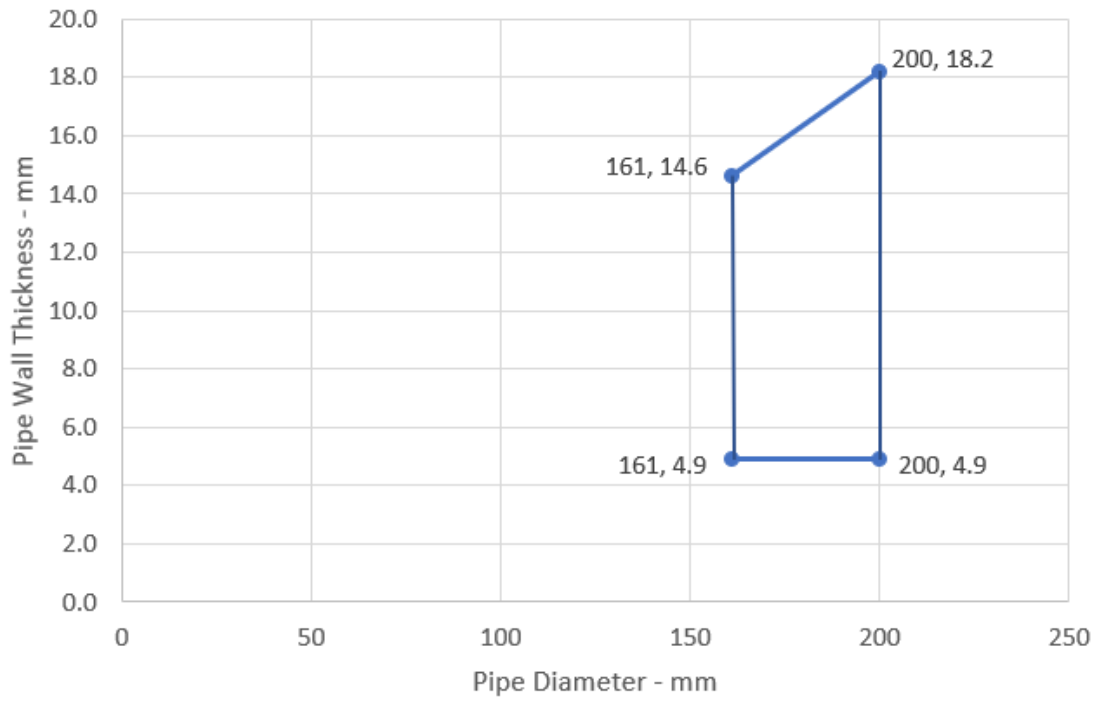

### PP Pipes - EI 60 C/C

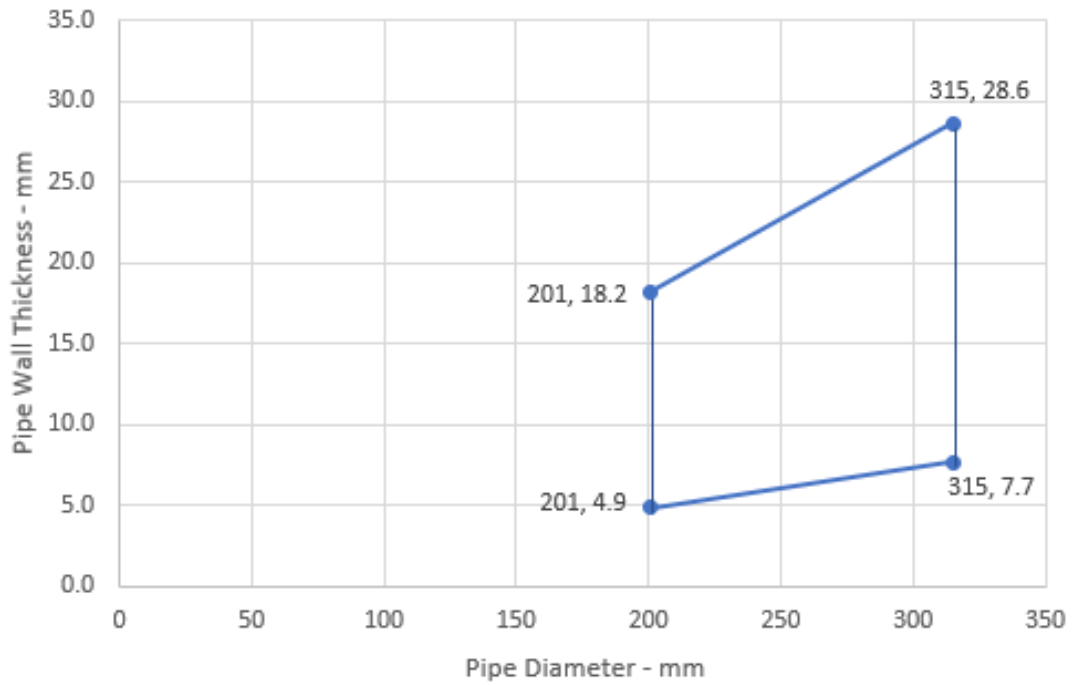

### PE Pipes 126-160 mm Diameter - E 240 U/U, EI 120 U/U

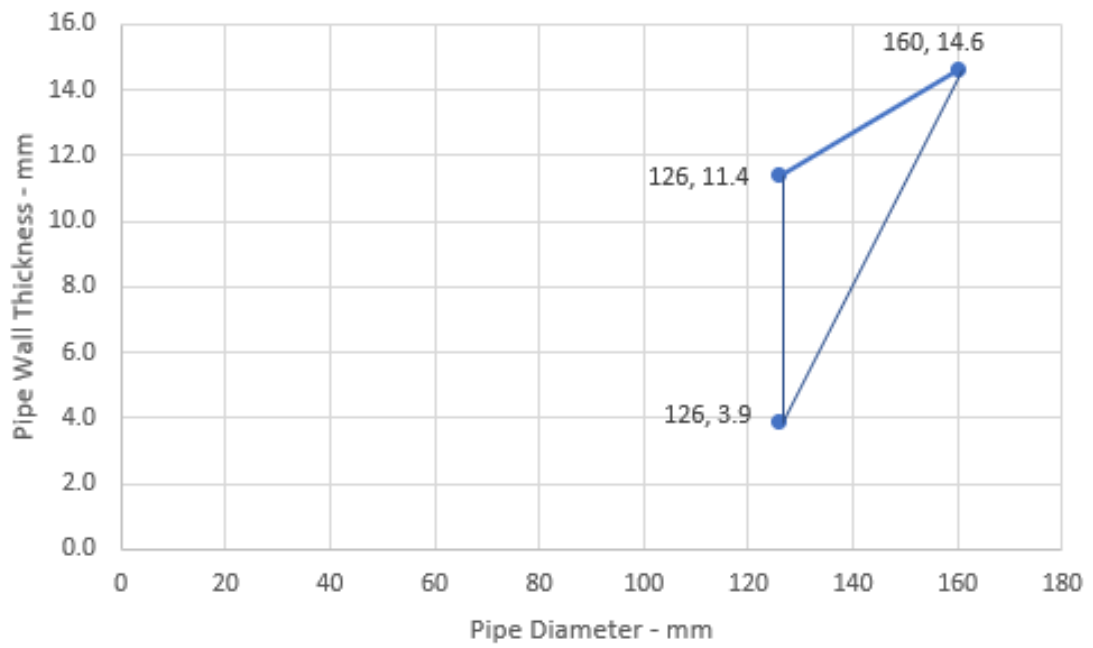

### PE Pipes - EI 60 C/C

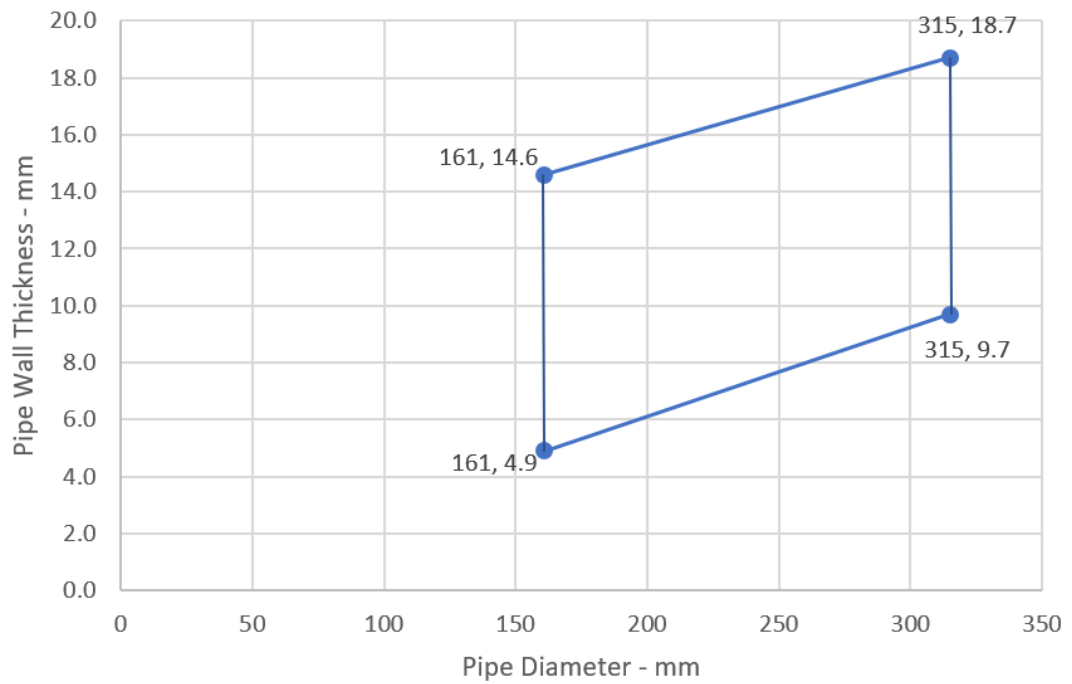

### A.2.7 Tytan Professional B1 Fire Wrap penetration seals, in 150 mm thick Tytan Professional B1 Fire Mortar Gypsum seals in rigid floors, with plastic pipes

**Penetration Seal:** Plastic pipes fitted at any position within the aperture (min. separation 30 mm from seal edges and from other services), with 150 mm Tytan Professional B1 Fire Mortar Gypsum to the bottom surface of the floor. Tytan Professional B1 Fire Wraps are required to be fitted to the bottom of the seal, as indicated below. Maximum seal size 2400 mm x 1200 mm.

Construction details:

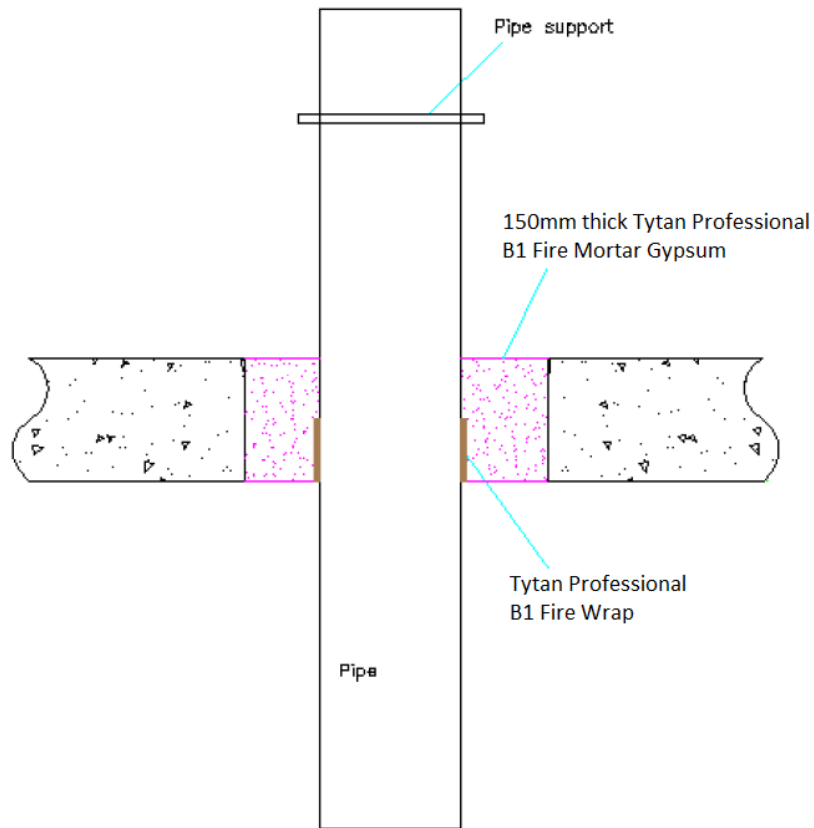

**Configuration 1**

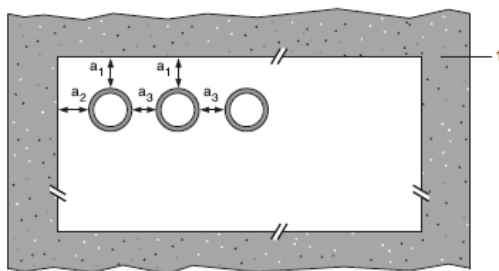

**Configuration 2**

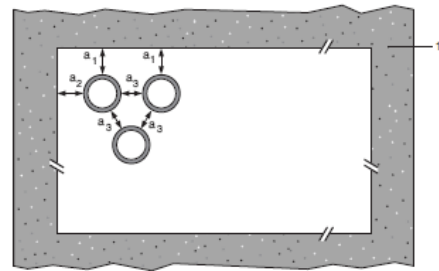

**Key**

- 1 Supporting construction
- a1 Pipe / top edge of seal separation
- a2 Pipe / side edge of seal separation
- a3 Pipe / pipe separation

## A.2.7.1

Services	Wrap	Permitted configuration for seal separation	Classification
<b>PVC-U pipe according to EN 1329-1, EN 1452-1 and EN 1453-1, PVC-C according to EN 1566-1</b>			
Up to 40 mm diameter/1.8-3.7 mm wall*	50 x 1.8	1 & 2	EI 120 U/U
Up to 125 mm diameter / 4.8-7.4 mm wall*	50 x 7.2 mm		EI 60 U/U
Up to 160 mm diameter/9.5 mm wall*	75 x 7.2 mm		E 120 U/U, EI 30 U/U
<b>PP pipe according to EN 1451-1</b>			
Up to 40 mm diameter/1.8-5.5 mm wall*	50 x 1.8	1 & 2	EI 120 U/U
Up to 125 mm diameter / 11.4 mm wall*	50 x 7.2 mm		EI 240 U/U
Up to 160 mm diameter/14.6 mm wall*	75 x 7.2 mm		EI 240 U/U
<b>PE pipe according to EN 1519-1, EN 12201-2 and EN 12666-1, ABS according to EN 1455-1 and pipes made from SAN+PVC according to EN 1565-1</b>			
Up to 40 mm diameter/2.4-3.7 mm wall*	50 x 1.8 mm	1 & 2	EI 240 U/U
Up to 110 mm diameter/3.4-10 mm wall*	75 x 5.4 mm		EI 240 U/U
Up to 125 mm diameter/11.4 mm wall*	50 x 7.2 mm		EI 240 U/U
Up to 160 mm diameter/4.9-14.6 mm wall*	75 x 7.2 mm		EI 120 U/U

\* Typical pipe diameters shown, see below graph for intermediate sizes

### PVC-U Pipes - E 60 U/U, EI 30 U/U

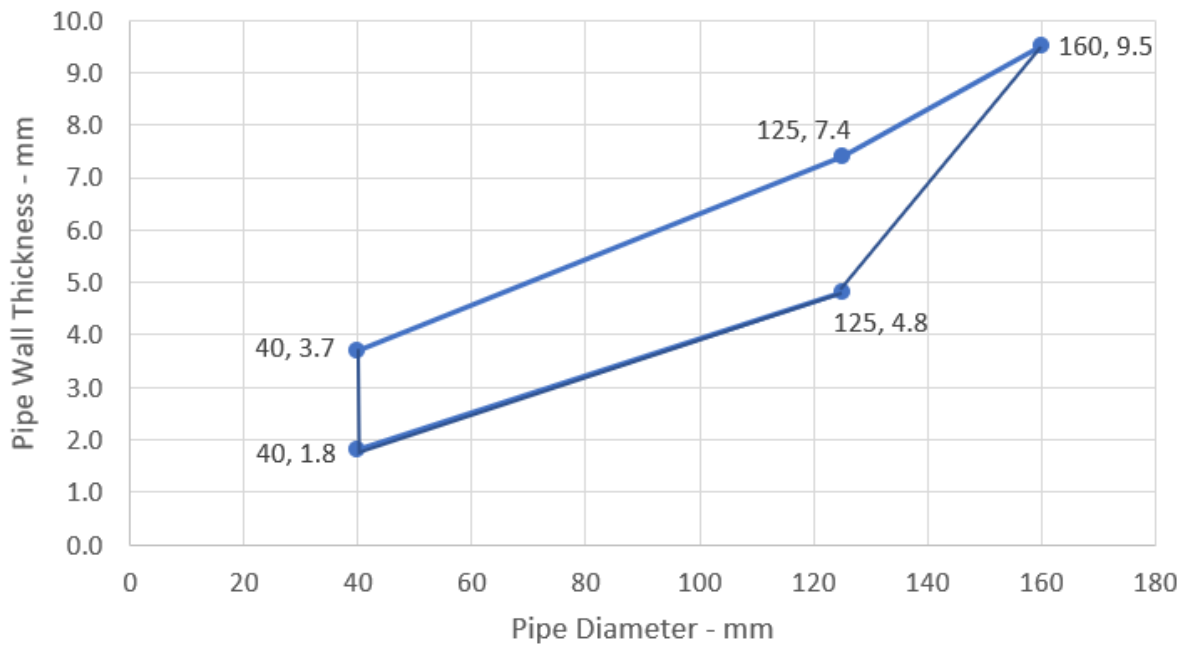

### PP Pipes - E 120 U/U

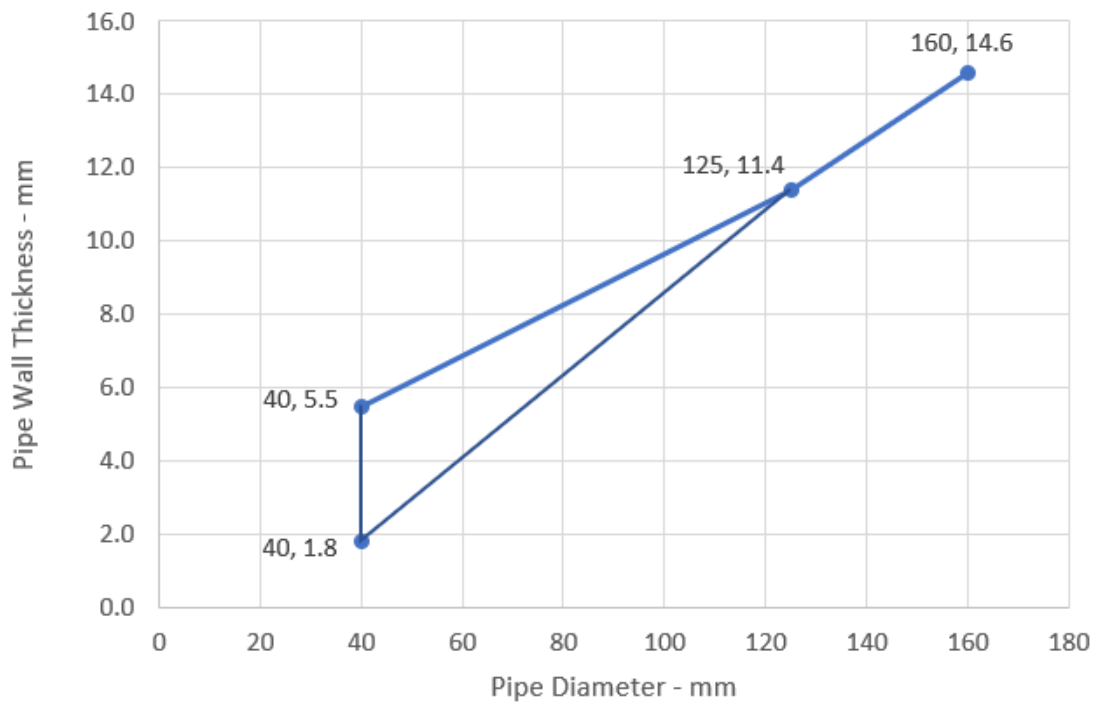

### PE Pipes - EI 120 U/U

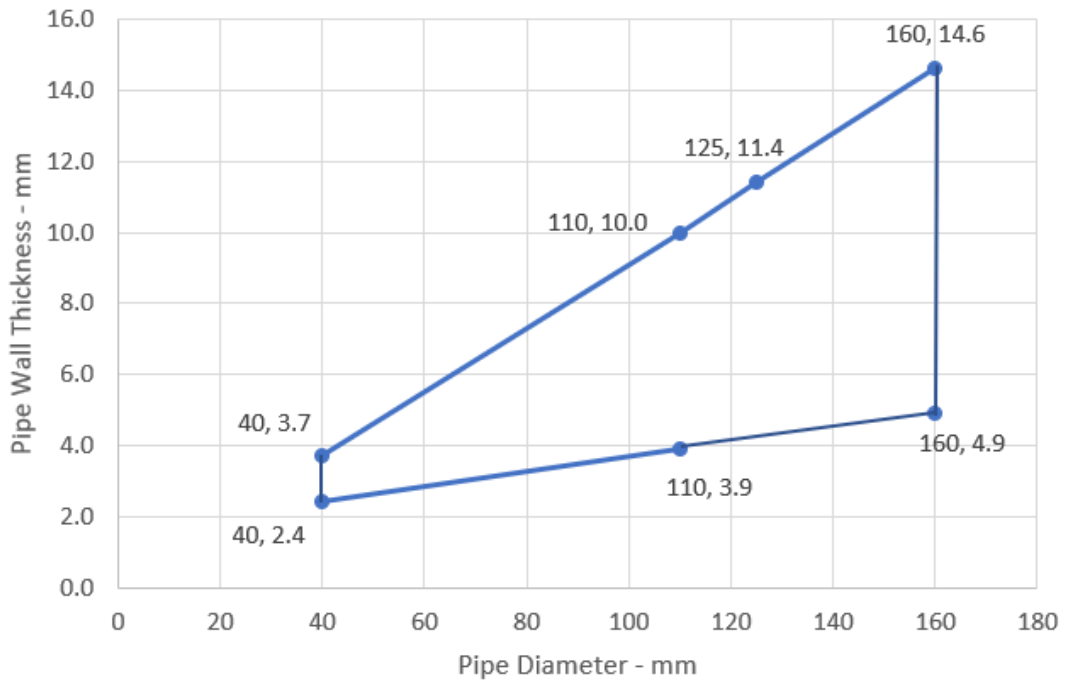

**A.2.8 Tytan Professional B1 Fire Wrap penetration seals, in 50 mm deep Tytan Professional B1 Fire Mortar Gypsum seals, backed with 50 mm stone wool, in rigid floors, with plastic pipes**

**Penetration Seal:** Plastic pipes (single) fitted at any position within the aperture (min. separation 30 mm from seal edges and 30 mm from other services), with 50 mm Tytan Professional B1 Fire Mortar Gypsum flush with the top of floor, backed with 50 mm stone wool 150 kg/m<sup>3</sup>. Tytan Professional B1 Fire Wraps are required to be fitted into the mortar seal.

Construction details:

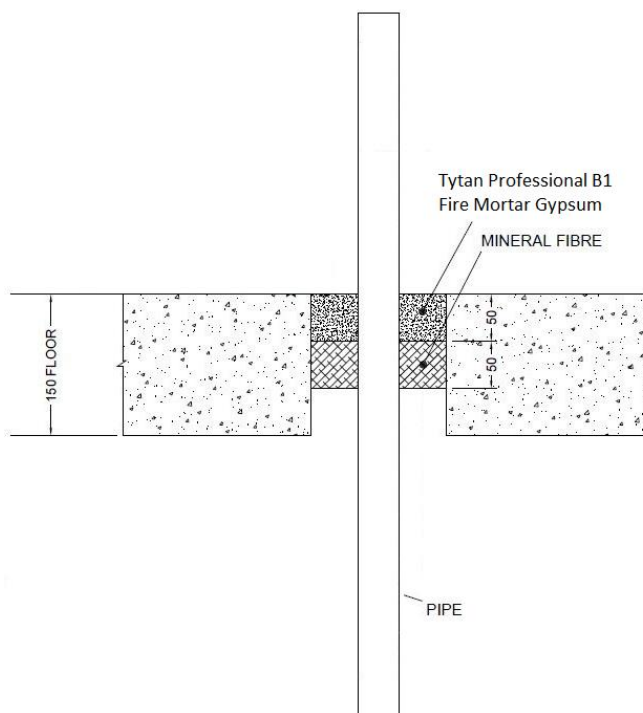

**A.2.8.1**

Services	Wrap	Maximum aperture	Classification
<b>PE pipe according to EN 1519-1, EN 12201-2 and EN 12666-1, ABS according to EN 1455-1 and pipes made from SAN+PVC according to EN 1565-1</b>			
110 mm diameter / 4.3 mm wall	50 x 2 mm	2400 x 1200 mm	<b>EI 60 C/C</b>

### A.3 Flexible and rigid wall constructions with a minimum thickness 100 mm

#### A.3.1 Tytan Professional B1 Fire Wrap penetration seal for insulated metal pipes, in seals comprising 25 mm deep Tytan Professional B1 Fire Mortar Gypsum to both faces backed with 50 mm mineral fibre board, installed within flexible or rigid wall

**Penetration Seal:** CS (Continuous Sustained) insulated metallic pipes fitted at any position within the aperture (min. separation 30 mm from seal edges), with 25 mm Tytan Professional B1 Fire Mortar Gypsum to both sides of the wall, backed with 50 mm stone wool board 150 kg/m<sup>3</sup> or 50 mm Tytan Professional B1 Fire Mortar Gypsum to both sides of the wall without backing\*. Tytan Professional B1 Fire Wraps are required to be fitted to both faces of the seal.

Construction details:

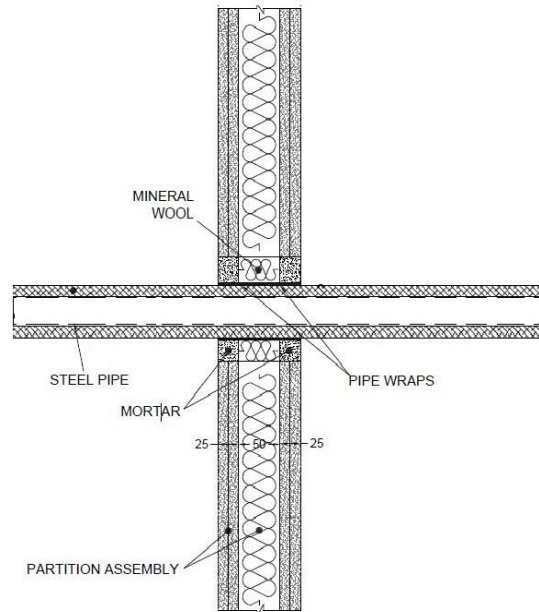

\* Maximum seal size of 2400 mm wide x 1200 mm high



**A.3.1.1**

Services	Wrap	Insulation	Classification
Mild or stainless steel pipe			
40 mm diameter/1-14.2 mm wall	2 off 50 x 1.8 mm Tytan Professional B1 Fire Wrap, one fitted flush to each face of seal	13 mm Elastomeric insulation minimum class B-s3,d0 or PE Foam insulation	<b>EI 120 C/U</b>
40 mm diameter/1-14.2 mm wall*	2 off 50 x 3.6 mm Tytan Professional B1 Fire Wrap, one fitted flush to each face of seal		<b>E 120 C/U, EI 60 C/U</b>
50 mm diameter/1.3-14.2 mm wall*			
60 mm diameter/1.6-14.2 mm wall*			
75 mm diameter/2-14.2 mm wall*			
90 mm diameter/2.4-14.2 mm wall*			
100 mm diameter/2.7-14.2 mm wall*			
115 mm diameter/3.1-14.2 mm wall*			
140 mm diameter/3.8-14.2 mm wall*			
165 mm diameter/ 4.5-14.2 mm wall*			

\* Typical pipe diameters shown, see below graph for intermediate sizes

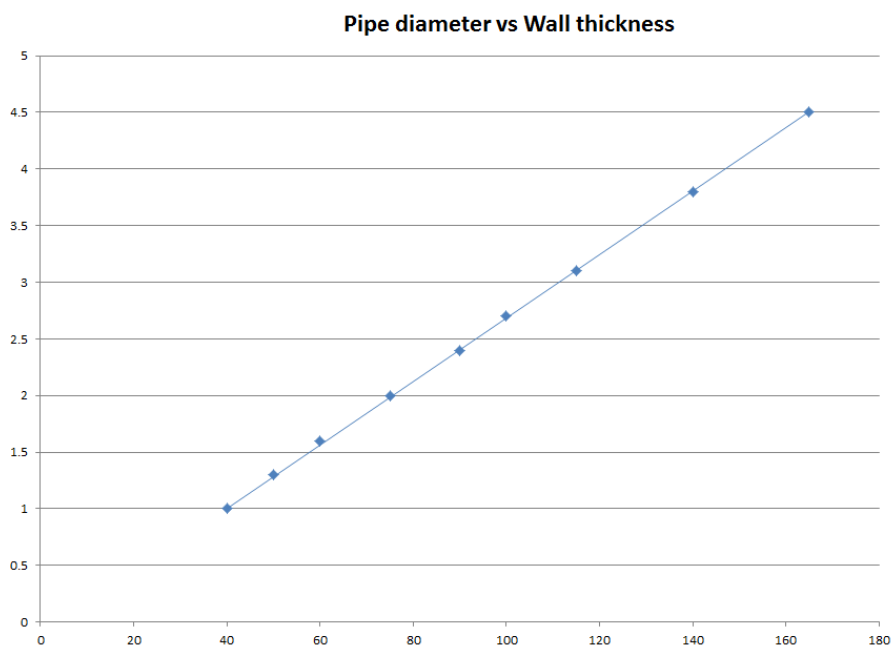

**A.3.2 Tytan Professional B1 Fire Wrap penetration seal for composite pipes, in seals comprising 25 mm deep Tytan Professional B1 Fire Mortar Gypsum to both faces backed with 50 mm mineral fibre board, installed within flexible or rigid wall**

**Penetration Seal:** 500 mm (min.)\* LI (Local Interrupted) or CI (Continuous Interrupted) insulated metallic ( and composite) pipes (single) fitted at any position within the aperture (min. separation 30 mm from seal edges and from other services), with 25 mm Tytan Professional B1 Fire Mortar Gypsum to both sides of the wall backed with 50 mm stone wool board 150 kg/m<sup>3</sup>. Maximum seal size 2400 mm wide x 1200 mm high

Construction details:

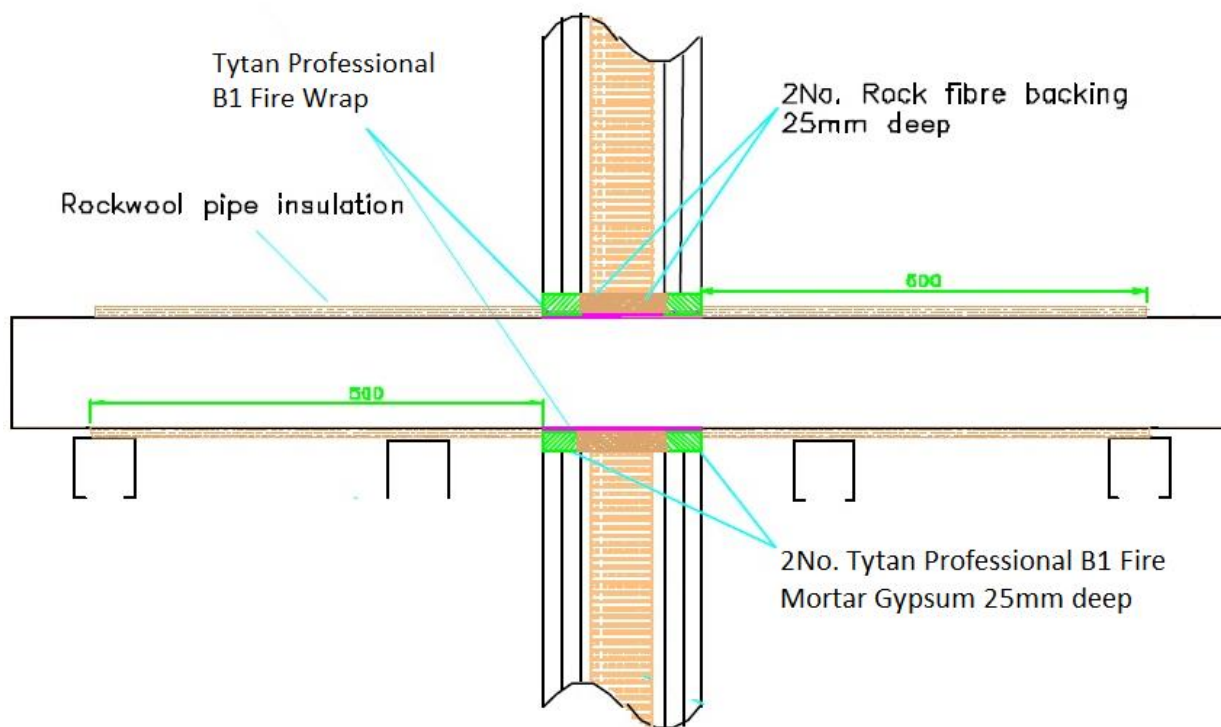

**A.3.2.1**

Services	Insulation	Classification
Geberit Mepla MLC (PE-Xb/Aluminium/PE-HD) pipe	Minimum 20 mm stone wool, minimum 80 kg/m <sup>3</sup>	EI 120 C/C
16 mm diameter/2.25 mm wall		
20 mm diameter/2.5 mm wall		
26 mm diameter/3 mm wall		
32 mm diameter/3 mm wall		
40 mm diameter/3.5 mm wall		
50 mm diameter/4 mm wall		
63 mm diameter/4.5 mm wall		
75 mm diameter/4.7 mm wall		

**A.3.3 Tytan Professional B1 Fire Wrap penetration seal for insulated metal & composite pipes, in seals comprising 25 mm deep Tytan Professional B1 Fire Mortar Gypsum to both faces backed with 50 mm mineral fibre board, installed within flexible or rigid wall**

**Penetration Seal:** CS (Continuous Sustained) insulated metallic and composite pipes fitted at any position within the aperture (min. separation 25 mm from seal edges), with 25 mm Tytan Professional B1 Fire Mortar Gypsum to both sides of the wall, backed with 25 mm stone wool 150 kg/m<sup>3</sup>\*. Tytan Professional B1 Fire Wraps are required to be fitted to both faces of the seal. Maximum seal size 2400 mm wide x 1200 mm long

Construction details:

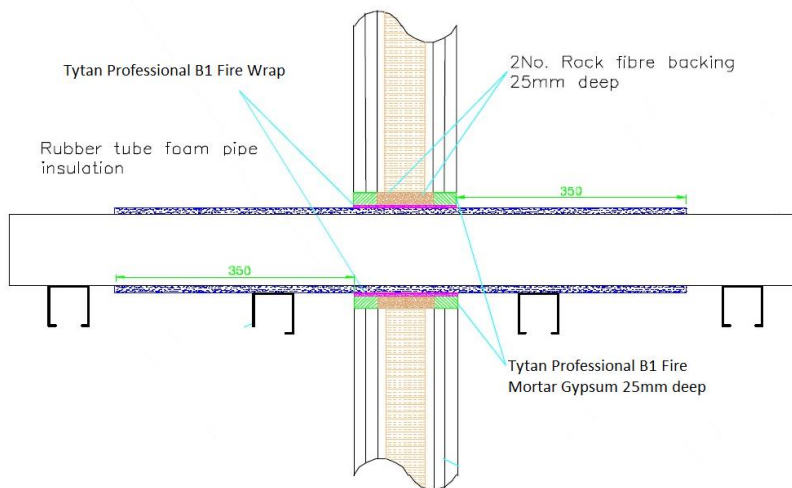

**A.3.3.1**

Services	Wrap	Insulation	Classification
Copper pipe			
12-54 mm diameter/1-1.2 mm wall	50 x 3.6 mm Tytan Professional B1 Fire Wrap fitted to both sides of the seal	9-25 mm Elastomeric insulation minimum class B-s3,d0 or PE Foam insulation	EI 120 C/C
Geberit Mepla MLC (PE-Xb/Aluminium/PE-HD pipe)			
16 mm diameter/2.25 mm wall	50 x 3.6 mm Tytan Professional B1 Fire Wrap fitted to both sides of the seal	9-25 mm Elastomeric insulation minimum class B-s3,d0 or PE Foam insulation	EI 120 C/C
20 mm diameter/2.5 mm wall			
26 mm diameter/3 mm wall			
32 mm diameter/3 mm wall			
40 mm diameter/3.5 mm wall			
50 mm diameter/4 mm wall			
63 mm diameter/4.5 mm wall			
75 mm diameter/4.7 mm wall			

**A.3.4 Tytan Professional B1 Fire Wrap penetration seal for insulated metal pipes, in seals comprising 50 mm deep Tytan Professional B1 Fire Mortar Gypsum to both faces, installed within flexible or rigid wall**

**Penetration Seal:** CS (Continuous Sustained) insulated metallic pipes fitted at any position within the aperture (min. separation 30 mm from seal edges), 50 mm Tytan Professional B1 Fire Mortar Gypsum to both sides of the wall without backing\*. Tytan Professional B1 Fire Wraps are required to be fitted to both faces of the seal.

Construction details:

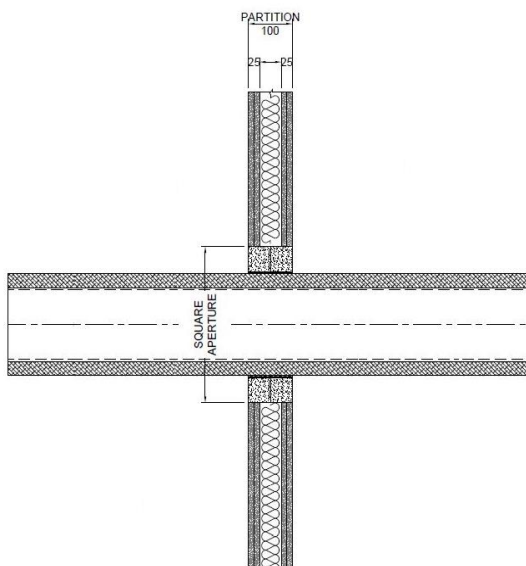

\* Maximum seal size of 2400 mm wide x 1200 mm high

**A.3.4.1**

Services	Wrap	Insulation	Classification
Mild or stainless steel pipe	2 off 50 x 3.6 mm Tytan Professional B1 Fire Wrap, one fitted flush to each face of seal	13 -32 mm Elastomeric insulation minimum class B-s3,d0 or PE Foam insulation	<b>E 120 C/U, EI 60 C/U</b>
40 mm diameter/1-14.2 mm wall*			
50 mm diameter/1.3-14.2 mm wall*			
60 mm diameter/1.6-14.2 mm wall*			
75 mm diameter/2-14.2 mm wall*			
90 mm diameter/2.4-14.2 mm wall*			
100 mm diameter/2.7-14.2 mm wall*			
115 mm diameter/3.1-14.2 mm wall*			
140 mm diameter/3.8-14.2 mm wall*			
165 mm diameter/ 4.5-14.2 mm wall*			

\* Typical pipe diameters shown, see below graph for intermediate sizes

**Pipe diameter vs Wall thickness**

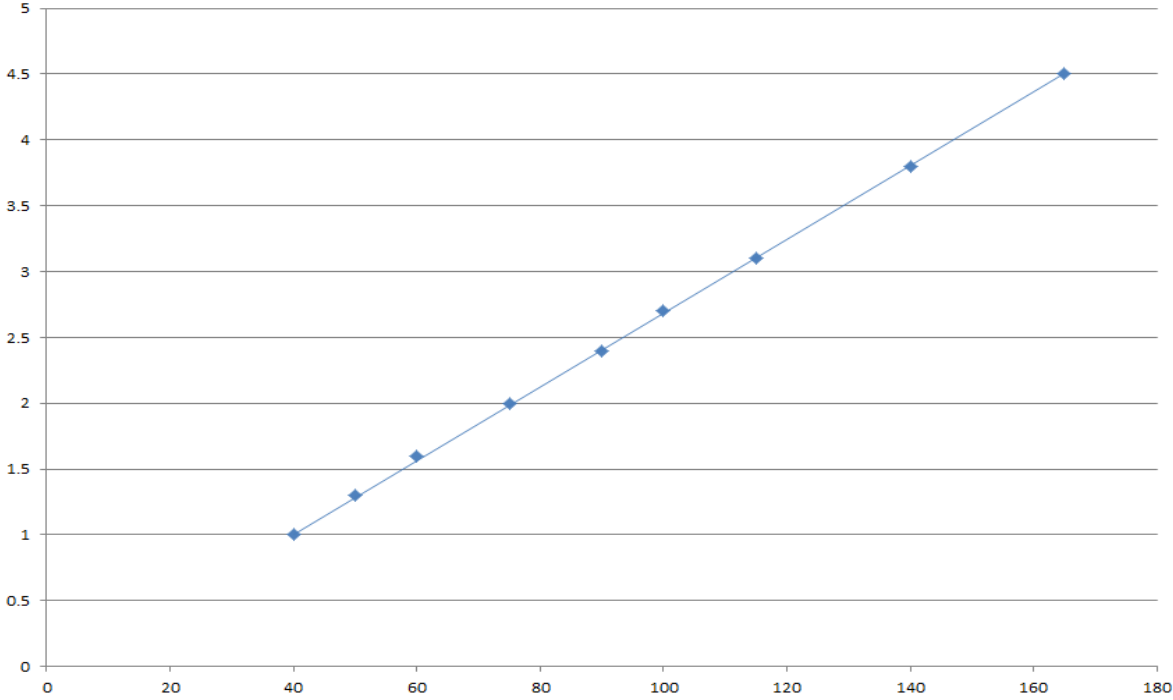

**A.4 Rigid wall constructions with floor thickness of minimum 150 mm**

**A.4.1 Tytan Professional B1 Fire Wrap penetration seal for insulated metal pipes, in 1x Tytan Professional B1 Fire Board 2-S seals, in rigid walls**

**Penetration Seal:** CS (Continuous Sustained) insulated metallic pipes fitted at any position within the aperture, with 60 mm Tytan Professional B1 Fire Board 2-S to either side of the wall (or anywhere in between). Tytan Professional B1 Fire Wraps are required to be fitted around combustible pipe insulation.

Construction details:

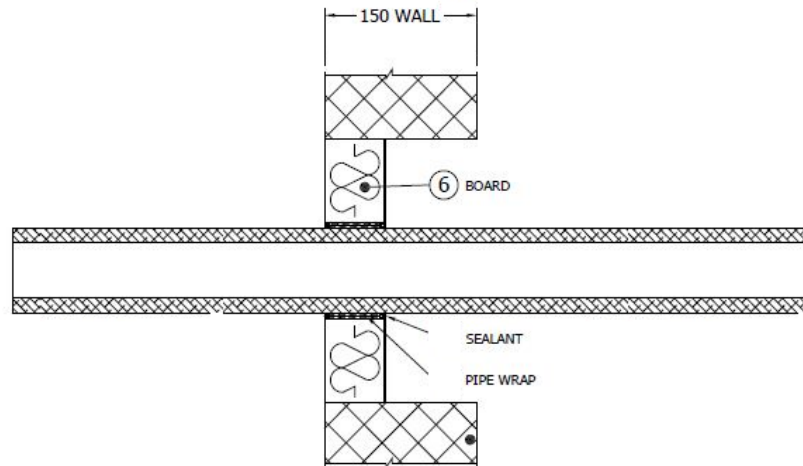

**A.4.1.1**

Services	Wrap	Insulation	Classification
Mild or stainless steel pipe			
165 mm diameter/ 4.5-14.2 mm wall	50 x 1.8 mm Tytan Professional B1 Fire Wrap fitted centrally	9-25 mm Elastomeric insulation minimum class B-s3,d0 or PE Foam insulation	<b>E 120 U/C, E 120 C/U, E 120 C/C, EI 45 U/C, EI 45 C/U, EI 45 C/C</b>

### A.4.2 Tytan Professional B1 Fire Wrap penetration seal for insulated metal pipes, in 2x Tytan Professional B1 Fire Board 2-S seals, in rigid walls

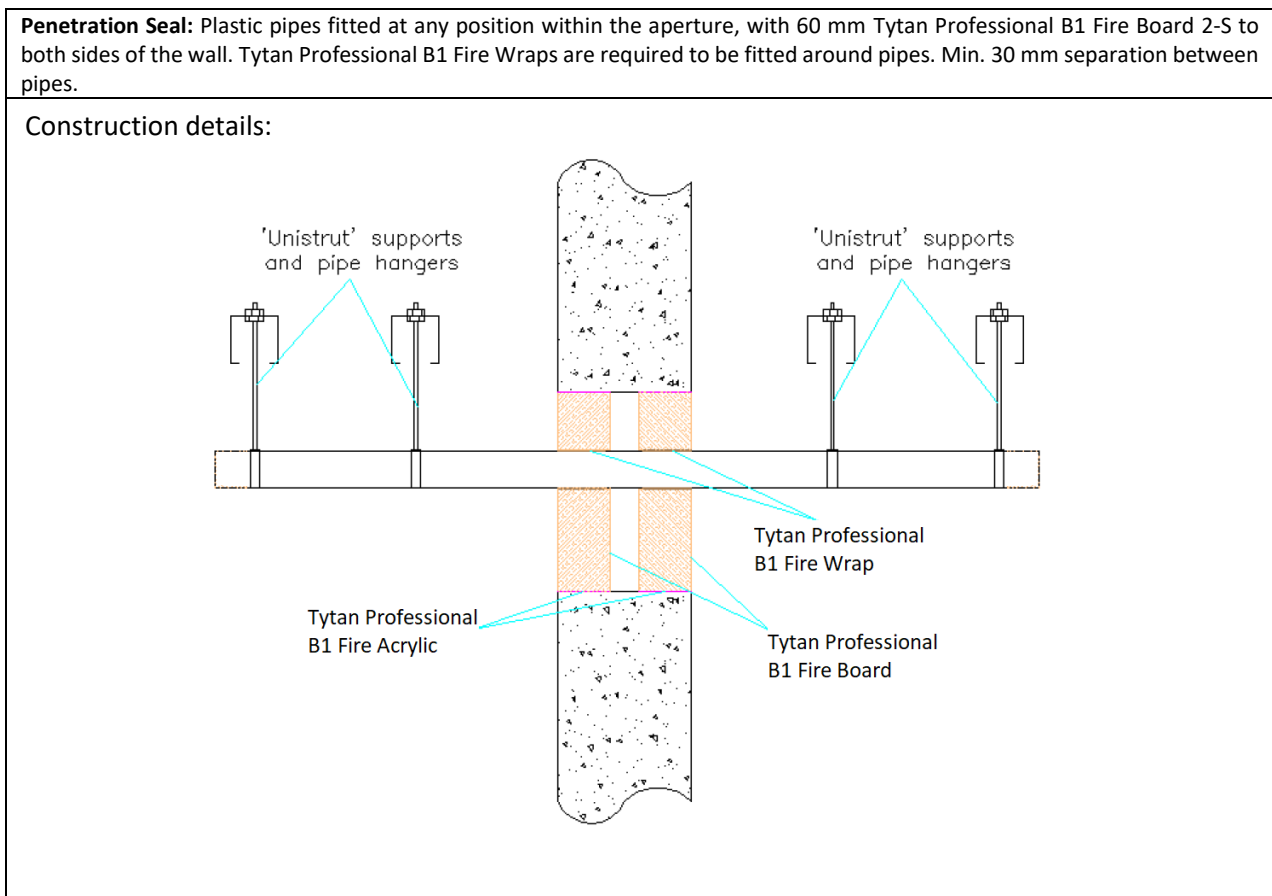

#### A.4.2.1

Services	Wrap	Classification
<b>PVC-U pipe according to EN 1329-1, EN 1452-1 and EN 1453-1 and PVC-C according to EN 1566-1</b>		
Up to 40 mm diameter / 1.9-3.0 mm wall	50 x 1.8 mm	<b>EI 240 U/C</b>
Up to 110 mm diameter / 2.7-6.6 mm wall	50 x 3.6 mm	
Up to 125 mm diameter / 4.7-7.4 mm wall	50 x 7.2 mm	
Up to 160 mm diameter / 4.0-9.5 mm wall*	50 x 10.8 mm	
Up to 315 mm diameter/7.7-12.1 mm wall thickness*#	75 x 18 mm	<b>EI 120 C/C</b>
Up to 400 mm diameter/9.8-15.3 mm wall thickness*#	75 x 28.8 mm	<b>EI 120 C/C</b>
<b>PE pipe according to EN 1519-1, EN 12201-2 and EN 12666-1, ABS according to EN 1455-1 and pipes made from SAN+PVC according to EN 1565-1</b>		
Up to 40 mm diameter / 2.4-4.6 mm wall	50 x 1.8 mm	<b>EI 240 U/C</b>
Up to 110 mm diameter / 3.4-10.0 mm wall	50 x 3.6 mm	
Up to 125 mm diameter / 3.9-7.4 mm wall	50 x 7.2 mm	
Up to 160 mm diameter / 4.9-9.5 mm wall	50 x 10.8 mm	
<b>PP pipe according to EN 1451-1</b>		
Up to 40 mm diameter / 1.8-5.5 mm wall	50 x 1.8 mm	<b>EI 240 U/C</b>
Up to 110 mm diameter / 2.7-10.0 mm wall	50 x 3.6 mm	<b>EI 240 C/C</b>
Up to 125 mm diameter / 3.1-11.4 mm wall	50 x 7.2 mm	
Up to 160 mm diameter / 4.9-14.6 mm wall	50 x 10.8 mm	

\* Typical pipe diameters shown, see below graph for intermediate sizes.

# Configuration 1 & 2

### PVC-U Pipes - EI 120 C/C

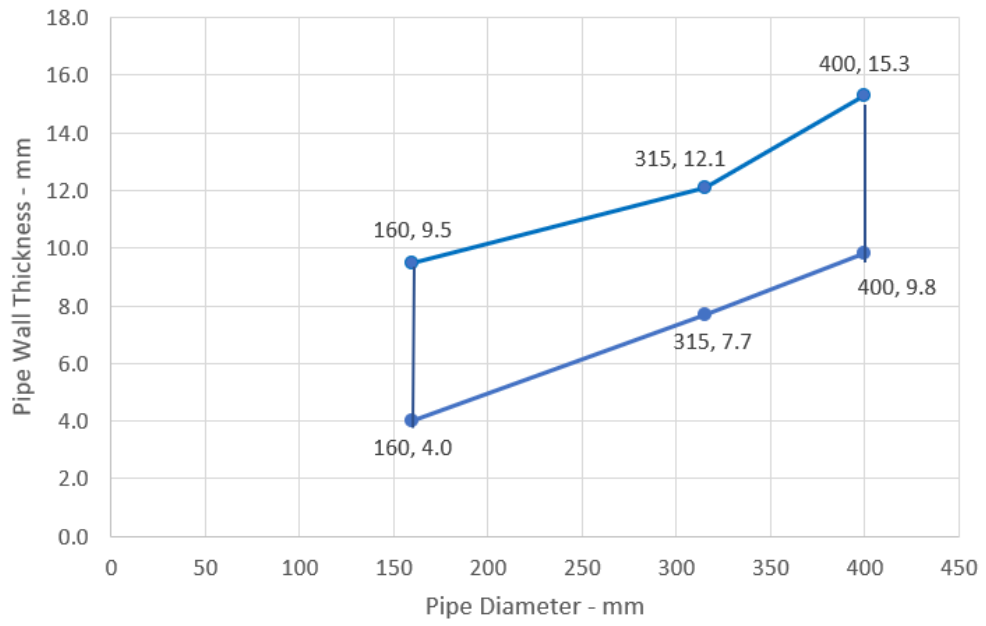



**A.5 Rigid floor constructions with floor thickness of minimum 150 mm**

**A.5.1 Tytan Professional B1 Fire Wrap penetration seal for plastic pipes, in 1x Tytan Professional B1 Fire Board 2-S, in rigid floors**

**Penetration Seal:** Combustible pipes fitted at any position within the aperture, with 50 mm Tytan Professional B1 Fire Board 2-S at mid-depth of the floor. Tytan Professional B1 Fire Wraps are required to be fitted around combustible pipe insulation. Maximum aperture size 2400 mm x 1200 mm

Construction details:

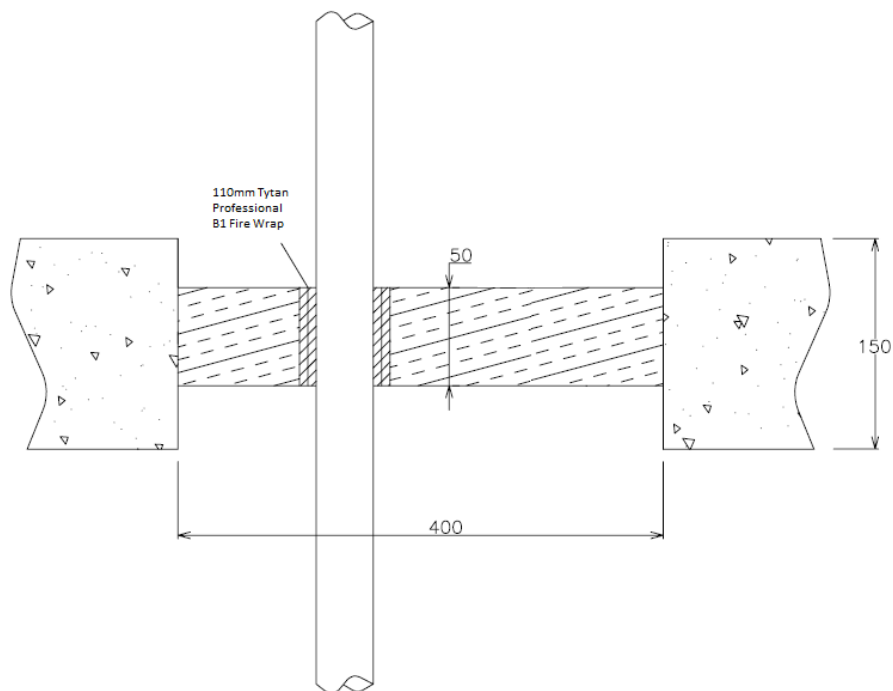

**A.5.1.1**

Services	Wrap	Classification
PVC-U pipe according to EN 1329-1, EN 1452-1 and EN 1453-1* 110 mm diameter/ 3.4mm wall	50 x 3.6 mm Tytan Professional B1 Fire Wrap	<b>EI 90 U/C, EI 90 C/C</b>

### A.5.2 Tytan Professional B1 Fire Wrap penetration seal for insulated metal pipes, in 1x Tytan Professional B1 Fire Board 2-S, in rigid floors

**Penetration Seal:** CS (Continuous Sustained) insulated metallic pipes fitted at any position within the aperture, with 60 mm Tytan Professional B1 Fire Board 2-S to either side of the floor (or anywhere in between). Tytan Professional B1 Fire Wraps are required to be fitted around combustible pipe insulation. Maximum aperture size 2400 mm x 1200 mm

Construction details:

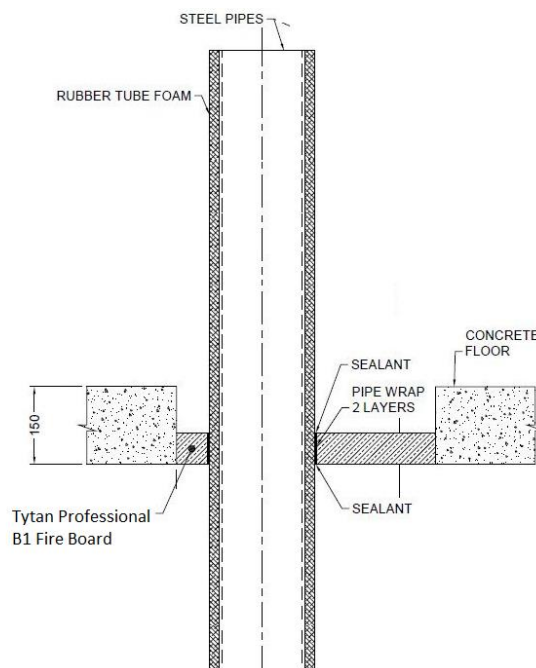

#### A.5.2.1

Services	Wrap	Insulation	Classification
Mild or stainless steel pipe			
165 mm diameter/ 4.5-14.2 mm wall	50 x 3.6 mm Tytan Professional B1 Fire Wrap fitted at bottom of seal	13 mm Elastomeric insulation minimum class B-s3,d0 or foil faced Phenolic Foam insulation	<b>E 90 C/U, EI 45 C/U</b>
		19 mm Elastomeric insulation minimum class B-s3,d0 or foil faced Phenolic Foam insulation	<b>EI 90 C/U</b>

### A.5.3 Tytan Professional B1 Fire Wrap penetration seal for insulated metal pipes in 2x Tytan Professional B1 Fire Board 2-S (separated), in rigid floors

**Penetration Seal:** CS (Continuous Sustained) insulated metallic pipes fitted at any position within the aperture, with 60 mm Tytan Professional B1 Fire Board 2-S to both sides of the floor. Tytan Professional B1 Fire Wrap are required to be fitted around combustible pipe insulation at the soffit. Maximum aperture size 2400 mm x 1200 mm

Construction details:

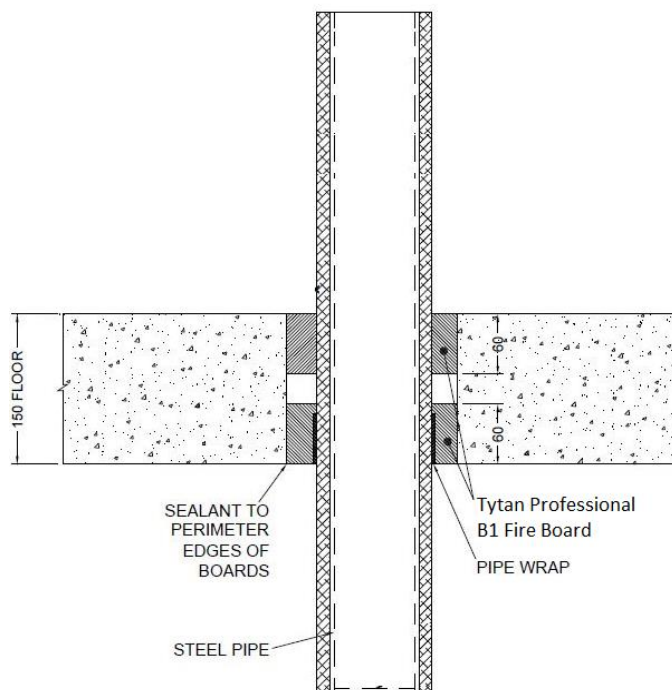

#### A.5.3.1 Double side penetration seal with pipes

Services	Wrap	Insulation	Classification
Mild or stainless steel pipe			
40 mm diameter/ 1-14.2 mm wall	50 x 1.8 mm Tytan Professional B1 Fire Wrap	13 mm Elastomeric insulation minimum class B-s3,d0 or foil faced Phenolic Foam insulation	<b>E 180 C/U, EI 120 C/U</b>

#### A.5.4 Tytan Professional B1 Fire Wrap penetration seal for insulated metal pipes, in 2x Tytan Professional B1 Fire Board 2-S (back to back), in rigid floors

**Penetration Seal:** CS (Continuous Sustained) insulated metallic and composite pipes fitted at any position within the aperture, with two layers of 60 mm Tytan Professional B1 Fire Board 1-S installed together to either side of the floor (or anywhere in between). Tytan Professional B1 Fire Wraps are required to be fitted around combustible pipe insulation at the bottom of the seal. Maximum aperture size 2400 mm x 1200 mm

Construction details:

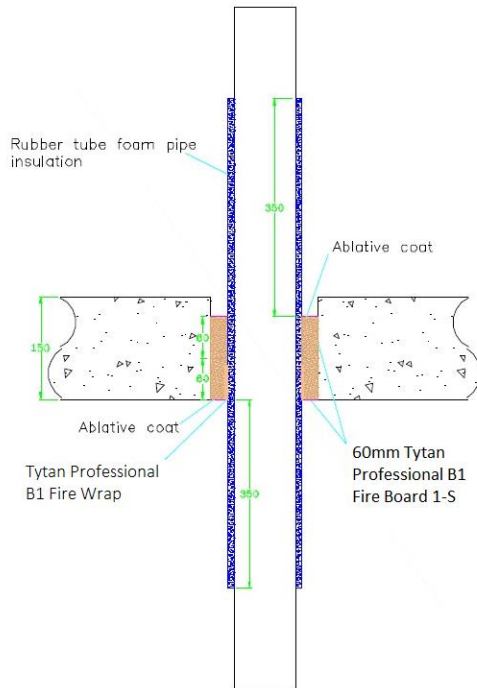

## A.5.4.1

Services	Wrap	Insulation	Classification
Copper pipe			
12-54 mm diameter/1-1.2 mm wall	50 x 3.6 mm Tytan Professional B1 Fire Wrap fitted to both sides of the seal	9-13 mm Elastomeric insulation minimum class B-s3,d0 or foil faced Phenolic Foam insulation	<b>E240 C/C, EI 60 C/C</b>
12-54 mm diameter/1-1.2 mm wall		13-25 mm Elastomeric insulation minimum class B-s3,d0 or foil faced Phenolic Foam insulation	<b>E 180 C/C, EI 45 C/C</b>
<b>Geberit Mepla MLC (PE-Xb/Aluminium/PE-HD pipe)</b>			
16 mm diameter/2.25 mm wall	50 x 3.6 mm Tytan Professional B1 Fire Wrap fitted to both sides of the seal	9 mm Elastomeric insulation minimum class B-s3,d0 or foil faced Phenolic Foam insulation	<b>EI 120 C/C</b>
20 mm diameter/2.5 mm wall			
26 mm diameter/3 mm wall			
32 mm diameter/3 mm wall			
40 mm diameter/3.5 mm wall			
50 mm diameter/4 mm wall			
63 mm diameter/4.5 mm wall		13-25 mm Elastomeric insulation minimum class B-s3,d0 or foil faced Phenolic Foam insulation	<b>E 60 C/C, EI 45 C/C</b>
75 mm diameter/4.7 mm wall			
16 mm diameter/2.25 mm wall			
20 mm diameter/2.5 mm wall			
26 mm diameter/3 mm wall			
32 mm diameter/3 mm wall			
40 mm diameter/3.5 mm wall			
50 mm diameter/4 mm wall			
63 mm diameter/4.5 mm wall			
75 mm diameter/4.7 mm wall			

**A.6 Flexible wall constructions according to 2. 1)**

**A.6.1 Tytan Professional B1 Fire Wrap penetration seal for insulated metal pipes, in 2x Tytan Professional B1 Fire Board 1-S in flexible or rigid walls**

**Penetration Seal:** CS (Continuous Sustained) insulated metallic pipes fitted at any position within the aperture, with 50 mm Tytan Professional B1 Fire Board 1-S to both sides of the wall. Minimum separation between penetration seals and seal edges of 30 mm. Tytan Professional B1 Fire Wraps are required to be fitted around the pipe insulation.

Construction details:

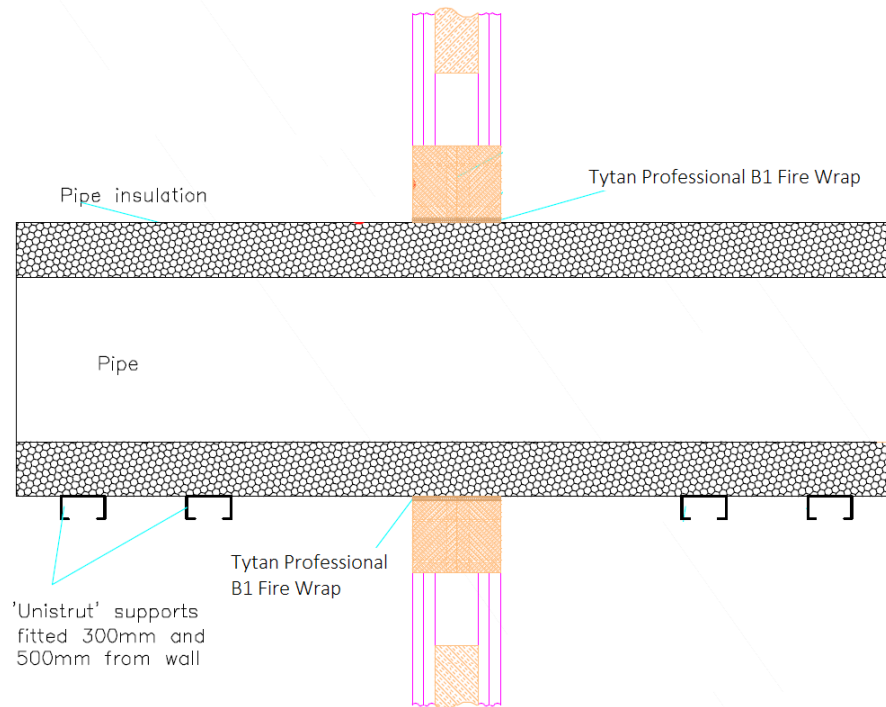

**Configuration 1**

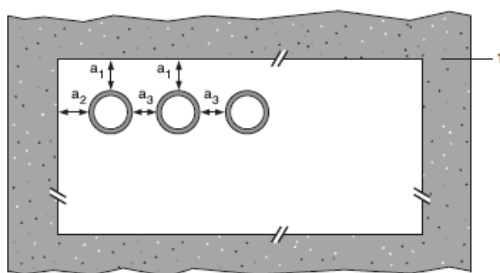

**Configuration 2**

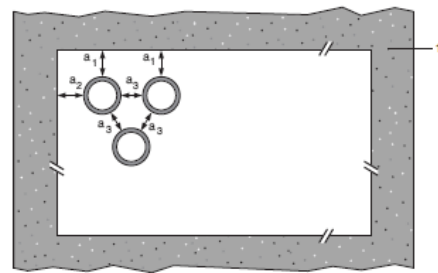

**Key**

- 1 Supporting construction
- a1 Pipe / top edge of seal separation
- a2 Pipe / side edge of seal separation
- a3 Pipe / pipe separation

**A.6.1.1**

Mild or stainless steel pipe	Insulation	Tytan Professional B1 Fire Wrap	Classification
40 mm diameter/1-14.2 mm wall*	32-50 mm thick Elastomeric insulation minimum class B-s3,d0 or PE Foam insulation	3 layers 50 x 1.8 mm	EI 90 C/U
50 mm diameter/1.2-14.2 mm wall*			
60 mm diameter/1.4-14.2 mm wall*			
75 mm diameter/1.6-14.2 mm wall*			
90 mm diameter/1.9-14.2 mm wall*			
100 mm diameter/2.1-14.2 mm wall*			
115 mm diameter/2.4-14.2 mm wall*			
140 mm diameter/2.9-14.2 mm wall*			
165 mm diameter/ 3.4-14.2 mm wall*			
180 mm diameter/ 3.6-14.2 mm wall*			
200 mm diameter/ 4.0-14.2 mm wall*			
219 mm diameter/ 4.3-14.2 mm wall*			
250 mm diameter/ 5.0-14.2 mm wall*			
300 mm diameter/ 5.9-14.2 mm wall*			
324 mm diameter/ 6.35-14.2 mm wall*			

**Pipe Diameter vs wall thickness**

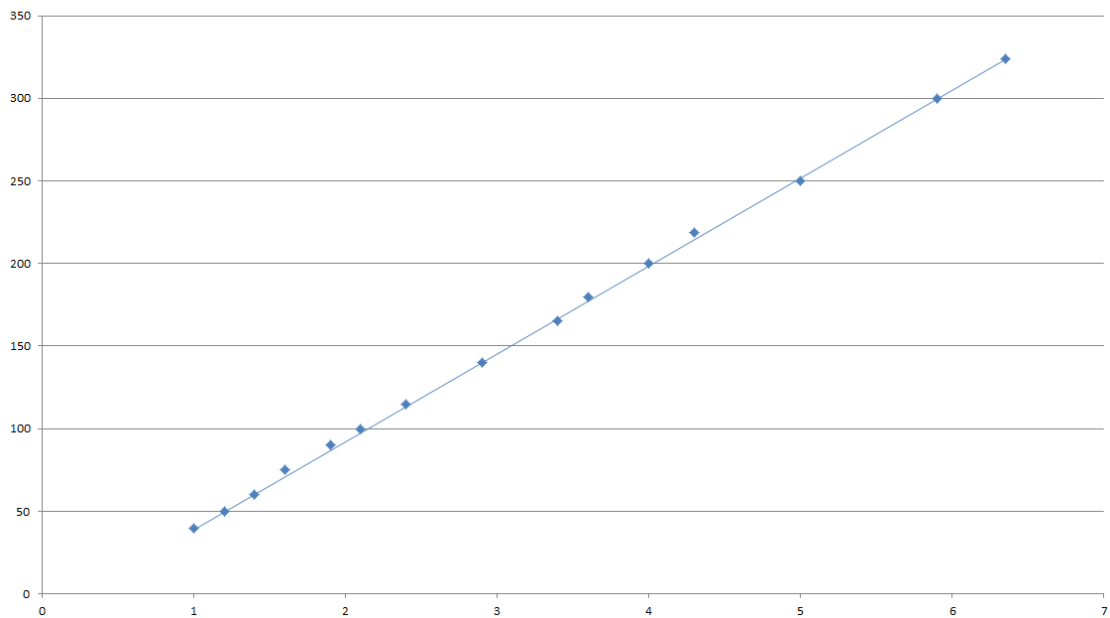

### A.6.2 Tytan Professional B1 Fire Wrap penetration seal for insulated metal pipes, in 2x Tytan Professional B1 Fire Board 1-S, in flexible or rigid walls

**Penetration Seal:** CS (Continuous Sustained) insulated metallic pipes fitted at any position within the aperture, with 50 mm Tytan Professional B1 Fire Board 1-S to both sides of the wall. Tytan Professional B1 Fire Wraps are required to be fitted around the pipe insulation.

Construction details:

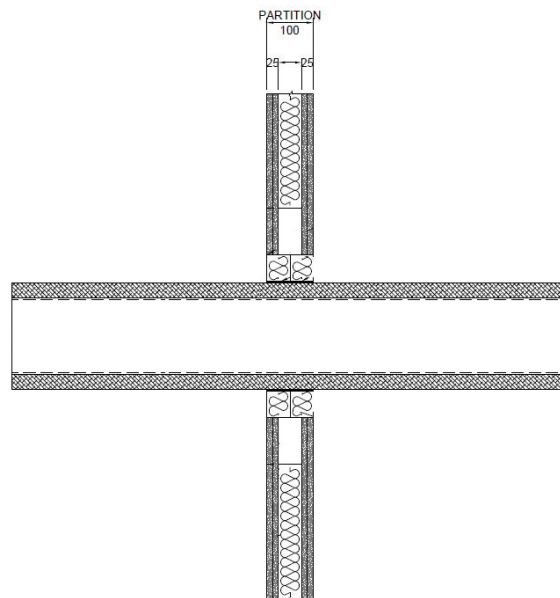
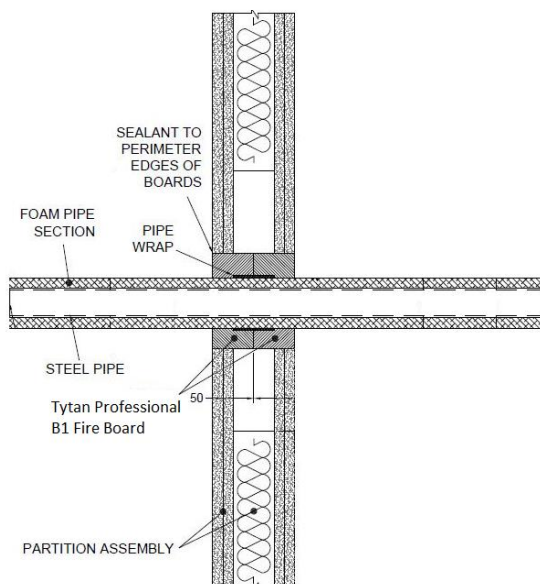

#### A.6.2.1

Services	Wrap	Insulation	Classification
Mild or stainless steel pipe			
40 mm diameter/1-14.2 mm wall	50 x 1.8 mm Tytan Professional B1 Fire Wrap fitted centrally	13 mm Elastomeric insulation minimum class B-s3,d0 or PE Foam insulation	<b>EI 120 U/C, EI 120 U/U, EI 120 C/U, EI 120 C/C</b>
40 mm diameter/1-14.2 mm wall*	2 off 50 x 3.6 mm Tytan Professional B1 Fire Wrap, one fitted flush to each face of seal	13 - 32mm Elastomeric insulation minimum class B-s3,d0 or PE Foam insulation	<b>E 120 U/C, E 120 U/U, E 120 C/U, E 120 C/C, EI 60 U/C, EI 60 U/U, EI 60 C/U, EI 60 C/C</b>
50 mm diameter/1.3-14.2 mm wall*			
60 mm diameter/1.6-14.2 mm wall*			
75 mm diameter/2-14.2 mm wall*			
90 mm diameter/2.4-14.2 mm wall*			
100 mm diameter/2.7-14.2 mm wall*			
115 mm diameter/3.1-14.2 mm wall*			
140 mm diameter/3.8-14.2 mm wall*			
165 mm diameter/ 4.5-14.2 mm wall*			

\* Typical pipe diameters shown, see below graph for intermediate sizes



**Pipe diameter vs Wall thickness**

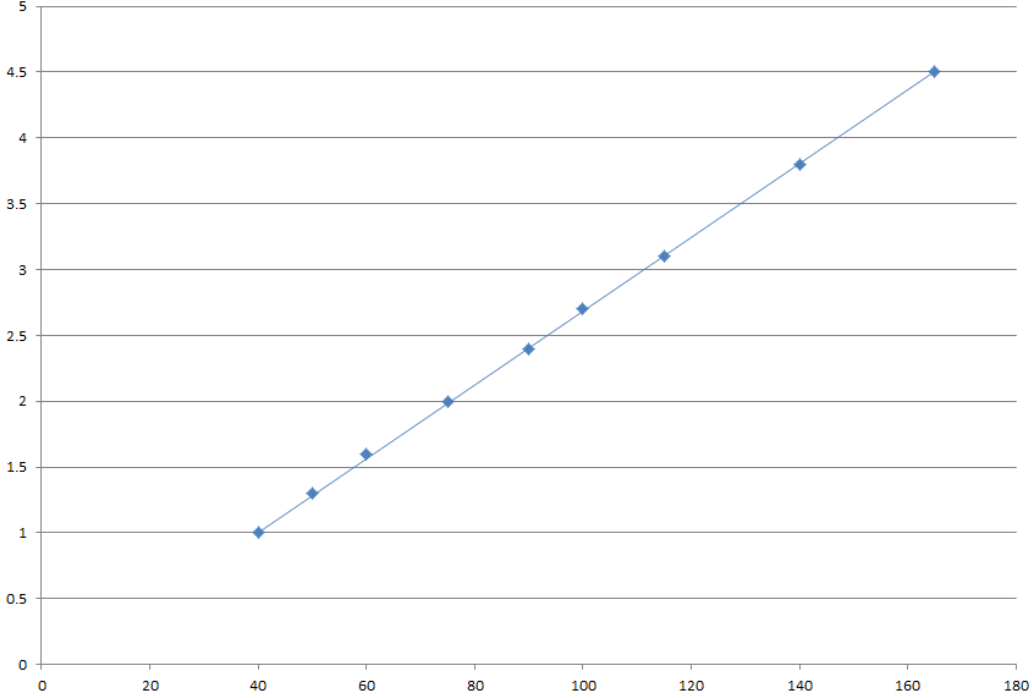

### A.6.3 Tytan Professional B1 Fire Wrap penetration seal for insulated metal pipes, in 2x Tytan Professional B1 Fire Board 1-S, in flexible or rigid walls

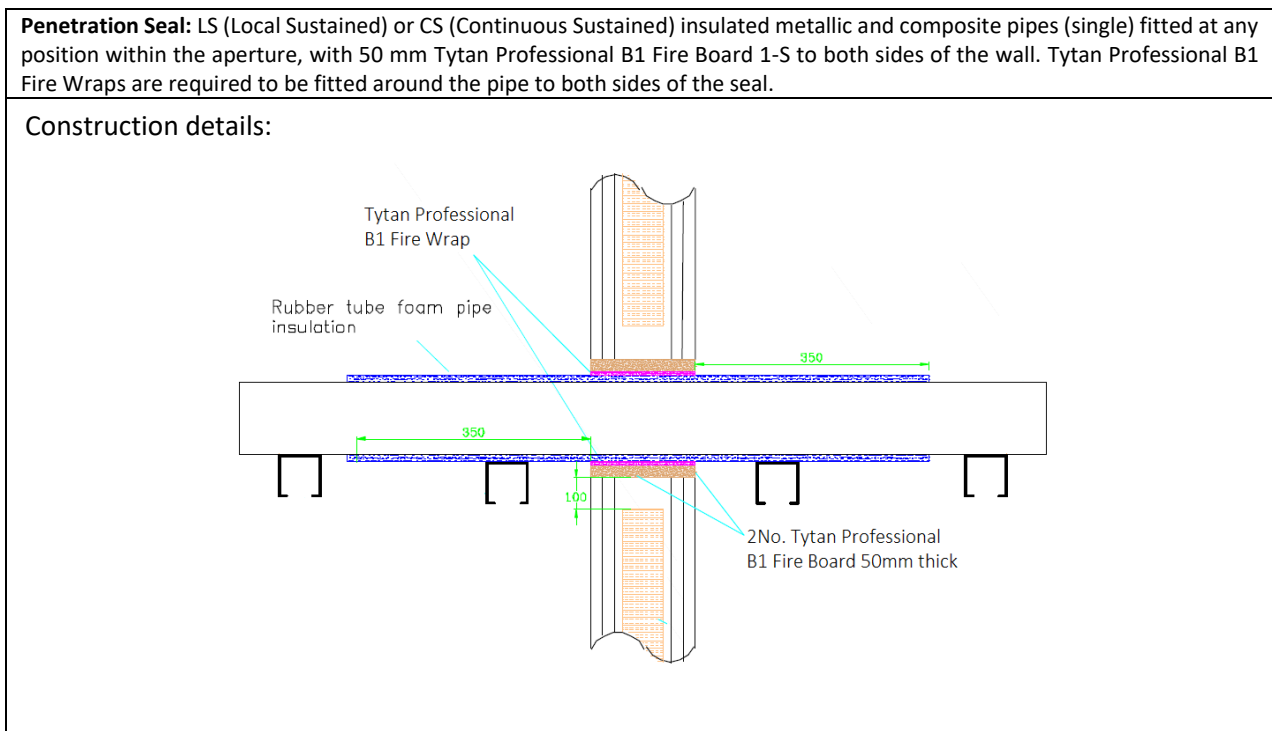

#### A.6.3.1

Services	Wrap	Insulation	Classification
Copper pipe			
12 mm diameter/1 mm wall	50 x 3.6 mm Tytan Professional B1 Fire Wrap fitted to both sides of the seal	9 mm Elastomeric insulation minimum class B-s3,d0 or PE Foam insulation	EI 120 C/C
12-54 mm diameter/1-1.2 mm wall		9-13 mm Elastomeric insulation minimum class B-s3,d0 or PE Foam insulation	E 120 C/C, EI 90 C/C
12-54 mm diameter/1-1.2 mm wall		13-25 mm Elastomeric insulation minimum class B-s3,d0 or PE Foam insulation	E 120 C/C, EI 60 C/C
Geberit Mepla MLC (PE-Xb/Aluminium/PE-HD pipe)*			
16 mm diameter/2.25 mm wall	50 x 3.6 mm Tytan Professional B1 Fire Wrap fitted to both sides of the seal	9-25 mm Elastomeric insulation minimum class B-s3,d0 or PE Foam insulation	EI 120 C/C
20 mm diameter/2.5 mm wall			
26 mm diameter/3 mm wall			
32 mm diameter/3 mm wall			
40 mm diameter/3.5 mm wall			
50 mm diameter/4 mm wall			
63 mm diameter/4.5 mm wall			
75 mm diameter/4.7 mm wall			

**A.6.4 Tytan Professional B1 Fire Wrap penetration seal for insulated metal pipes, in 2x Tytan Professional B1 Fire Board 1-S, in flexible or rigid walls**

**P Penetration Seal:** Combustible pipes (single) fitted central within the aperture, with Tytan Professional B1 Fire Board 1-S to both sides of the wall. Tytan Professional B1 Fire Wraps are required to be fitted around the pipe.

Construction details:

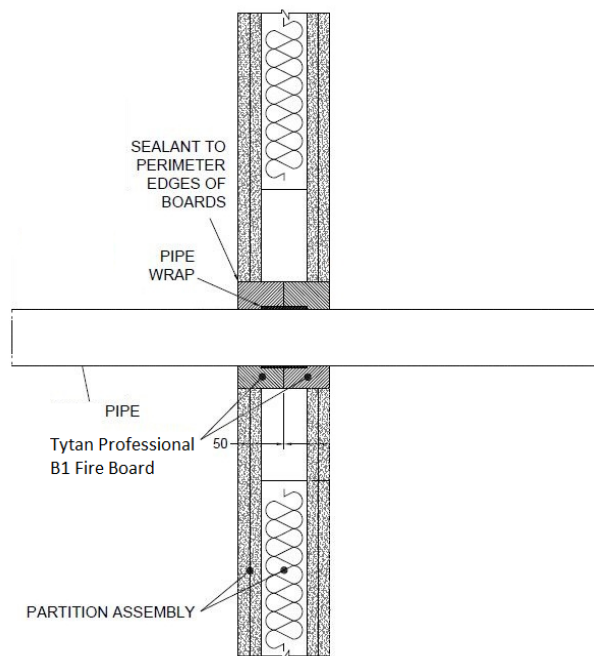

**A.6.4.1**

Services	Pipe Wrap	Classification
PVC-U pipe according to EN 1329-1, EN 1452-1 and EN 1453-1 315 mm $\varnothing$ /9.2 mm wall	Tytan Professional B1 Fire Wrap 75 x 18 mm fitted centrally around the pipe	EI 45 C/C

### A.6.5 Tytan Professional B1 Fire Wrap penetration seal for plastic pipes, in 2x Tytan Professional B1 Fire Board 1-S, in flexible or rigid walls

**Penetration Seal:** Combustible pipes sealed with Tytan Professional B1 Fire Wrap, to both sides of the wall. Minimum separation between penetration seals and seal edges of 30 mm. (Configuration 1 & 2).

Construction details:

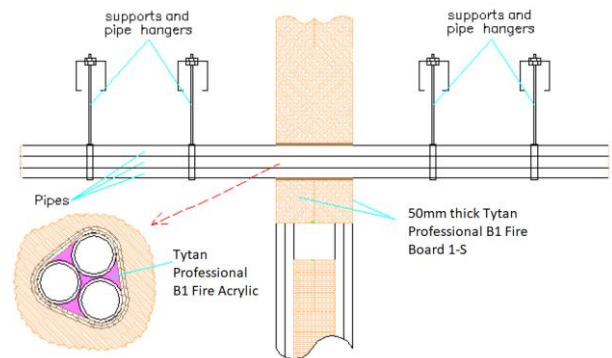
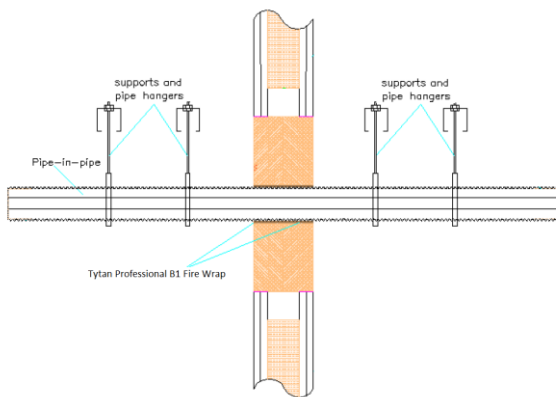
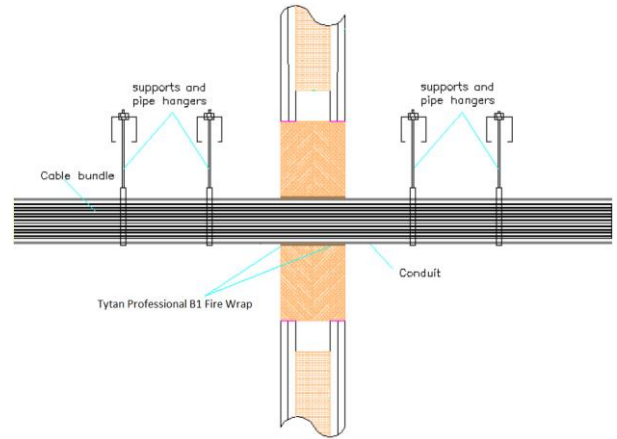
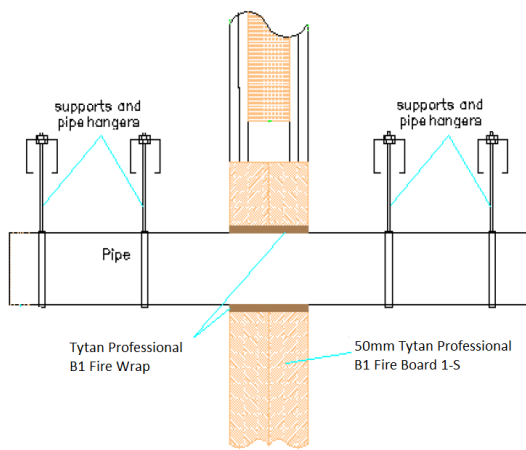

**Configuration 1**

**Configuration 2**

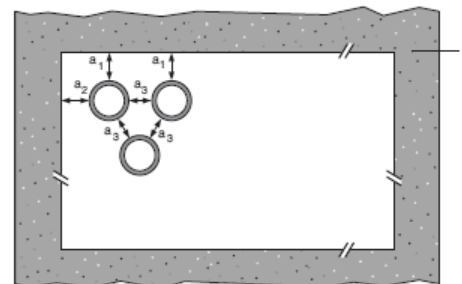
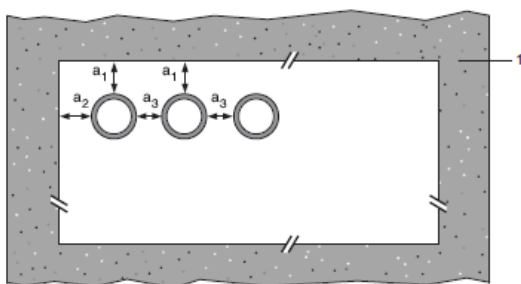

**Key**

1 Supporting construction

a1 Pipe / top edge of seal separation

a2 Pipe / side edge of seal separation

a3 Pipe / pipe separation

## A.6.5.1

Services	Wraps (both sides)	Permitted configuration for seal separation	Classification
PVC-U pipe according to EN 1329-1, EN 1452-2 and EN 1453-1 and PVC-C according to EN 1566-1			
Diameter up to 40 mm, wall thickness 1.9 – 3.0 mm	50 x 1.8 mm (1 layer)	1 & 2 between PVC-U/PVC-C, PE/ABS/SAN+PVC and PP pipes in any combination	EI 120 U/U, EI 120 C/U, EI 120 U/C, EI 120 C/C
Diameter up to 110 mm, wall thickness 2.7 - 6.6 mm	50 x 3.6 mm (2 x 1.8 layer)		E 120 U/C, E 120 C/C EI 90 U/C, EI 90 C/C
Diameter up to 125 mm, wall thickness 3.7 – 7.4 mm	50 x 5.4 mm (3 x 1.8 layer)		
Diameter up to 160 mm, wall thickness 9.5 mm *	50 x 7.2 mm (4 x 1.8 layer)		
Diameter up to 315 mm, wall thickness 7.7-12.1 mm*	50 x 18 mm (10 x 1.8 layers)	n/a	EI 90 C/C
Diameter up to 400 mm, wall thickness 9.8-15.3 mm*	50 x 28.8 mm (16 x 1.8 layers)	n/a	EI 90 C/C
Diameter up to 110 mm, wall thickness 2.7–6.6 mm, fully or partially filled conduits with cables up to 14 mm diameter	50 x 3.6 mm (2 x 1.8 layers)	1 & 2	E 120 U/C, EI 90 U/C
PE pipe according to EN 1519-1, EN 12201-2 and EN 12006-1, ABS according to EN 1455-1 and pipes made from SAN+PVC according to EN 1565-1			
Diameter up to 40 mm, wall thickness 2.4 – 3.7 mm	50 x 1.8 mm (1 layer)	1 & 2 between PVC-U/PVC-C, PE/ABS/SAN+PVC and PP pipes in any combination	EI 120 U/U, EI 120 C/U, EI 120 U/C, EI 120 C/C
Diameter up to 110 mm, wall thickness 4.2 - 10 mm	50 x 3.6 mm (2 x 1.8 layer)		E 120 U/C, E 120 C/C EI 90 U/C, EI 90 C/C
Diameter up to 125 mm, wall thickness 4.8 – 12 mm	50 x 5.4 mm (3 x 1.8 layer)		
Diameter up to 160 mm, wall thickness 14.6 mm	50 x 7.2 mm (4 x 1.8 layer)		
Diameter up to 110 mm, wall thickness 4.2–10 mm, fully or partially filled conduits with cables up to 14 mm diameter	50 x 3.6 mm (2 x 1.8 layers)	1 & 2	E 120 U/C, EI 90 U/C
PP pipe according to EN 1852-1: 2009			
Diameter up to 40 mm, wall thickness 1.8 – 5.5 mm	50 x 1.8 mm (1 layer)	1 & 2 between PVC-U/PVC-C, PE/ABS/SAN+PVC and PP pipes in any combination	EI 120 U/U, EI 120 C/U, EI 120 U/C, EI 120 C/C
Diameter up to 110 mm, wall thickness 2.7 - 15.1 mm	50 x 3.6 mm (2 x 1.8 layer)		EI 90 U/U, EI 90 C/U, EI 90 U/C, EI 90 C/C
Diameter up to 125 mm, wall thickness 3.1 – 17.1 mm	50 x 5.4 mm (3 x 1.8 layer)		
Diameter up to 160 mm, wall thickness 21.9 mm	50 x 7.2 mm (4 x 1.8 layer)		
Diameter up to 110 mm, wall thickness 2.7–15.1 mm, fully or partially filled conduits with cables up to 14 mm diameter	50 x 3.6 mm (2 x 1.8 layers)	1 & 2	E 120 U/C, EI 90 U/C
Uponor Wirsbo PEX pipe in pipe system according to ISO 15875			
Diameter up to 54 mm/4.0 mm wall thickness (outer pipe), 28 mm diameter/0.4 mm wall thickness (inner pipe)	50 x 3.6 mm (2 x 1.8 layers)	1 & 2	EI 120 C/C

Uponor Wirsbo PEX double pipe in pipe system			
Diameter up to 25 mm pipes, wall thickness 0.6 mm, in bundles up to 50 mm	50 x 3.6 mm (2 x 1.8 layers)	1 & 2	EI 90 C/C
BluePower Multilayer pipe according to EN 1451-1			
32-50 mm diameter/1.8 mm wall thickness*	50 x 3.6 mm (2 x 1.8 layers)	1 & 2	EI 90 U/U
75-110 mm diameter/3.4 mm wall thickness*	50 x 3.6 mm (2 x 1.8 layers)	1 & 2	EI 90 C/U
Rehau Raupiano Plus PP-DD according to DIN 4102			
40-50 mm diameter/1.8-2.7 mm wall thickness*	50 x 3.6 mm (2 x 1.8 layers)	1 & 2	EI 120 U/U
75-110 mm diameter/2.7 mm wall thickness*	50 x 3.6 mm (2 x 1.8 layers)	1 & 2	EI 120 U/C
125 mm diameter/3.9 mm wall thickness	50 x 7.2 mm (4 x 1.8 layers)	1 & 2	EI 120 U/C
160 mm diameter/3.9 mm wall thickness	50 x 10.8 mm (6 x 1.8 layers)	1 & 2	EI 120 U/C
Polo-Kal NG Poloplast PP-MV according to DIN 4102			
32-50 mm diameter/2.0-3.4 mm wall thickness*	50 x 3.6 mm (2 x 1.8 layers)	1 & 2	EI 120 U/U
75-110 mm diameter/3.4 mm wall thickness*	50 x 3.6 mm (2 x 1.8 layers)	1 & 2	EI 120 U/C
125 mm diameter/3.9 mm wall thickness	50 x 7.2 mm (4 x 1.8 layers)	1 & 2	EI 120 U/C
160 mm diameter/4.9 mm wall thickness	50 x 10.8 mm (6 x 1.8 layers)	1 & 2	EI 120 U/C
Aquatherm Green SDR9 MF PP-RP according to ISO 21003			
32 mm diameter/3.0 mm wall thickness	50 x 1.8 mm (1 x 1.8 layer)	1 & 2	E 120 C/C, EI 90 C/C
40-50 mm diameter/5.6-12.3 mm wall thickness*	50 x 3.6 mm (2 x 1.8 layers)	1 & 2	E 120 C/C, EI 90 C/C
63-110 mm diameter/12.3 mm wall thickness*	50 x 3.6 mm (2 x 1.8 layers)	1 & 2	E 120 C/C, EI 90 C/C
Wavin SiTech + PP-M B according to EN 13501-1			
32-50 mm diameter/1.8-3.4 mm wall thickness*	50 x 3.6 mm (2 x 1.8 layers)	1 & 2	E 120 U/U, EI 90 U/U
75-110 mm diameter/3.4 mm wall thickness*	50 x 3.6 mm (2 x 1.8 layers)	1 & 2	E 120 U/C, EI 60 U/C
Geberit Silent PP according to DIN 4102			
32-50 mm diameter/1.8-3.4 mm wall thickness*	50 x 3.6 mm (2 x 1.8 layers)	1 & 2	EI 120 U/U
75-110 mm diameter/3.4 mm wall thickness*	50 x 3.6 mm (2 x 1.8 layers)	1 & 2	EI 120 U/C

\*See below graph for interpolation pipe sizes

### PVC-U Pipes - E 90 C/C, EI 60 C/C

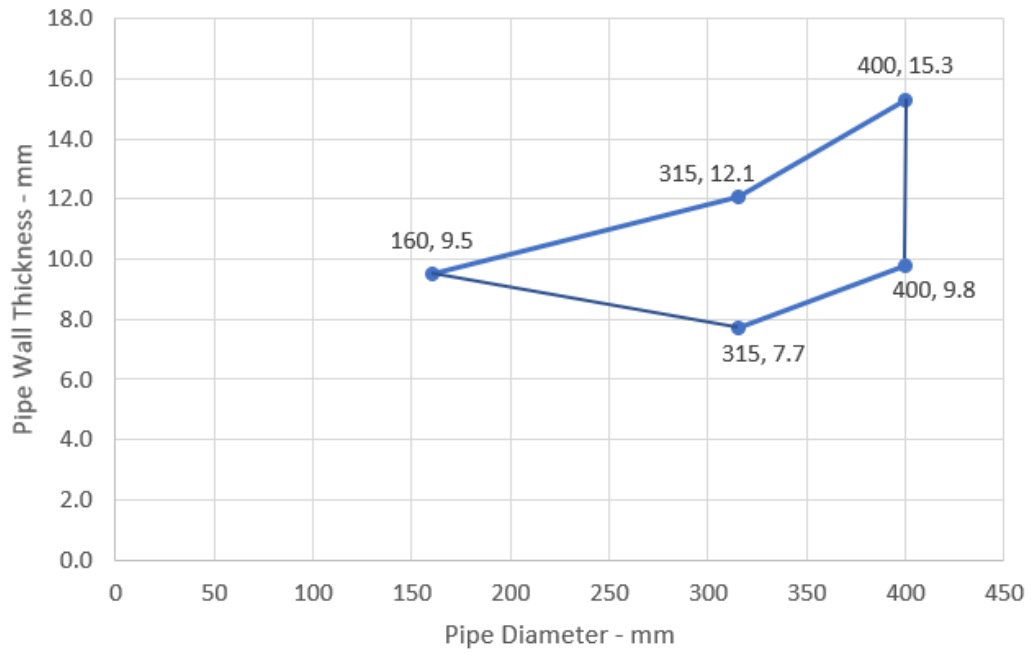

### BluePower - EI 90 C/U

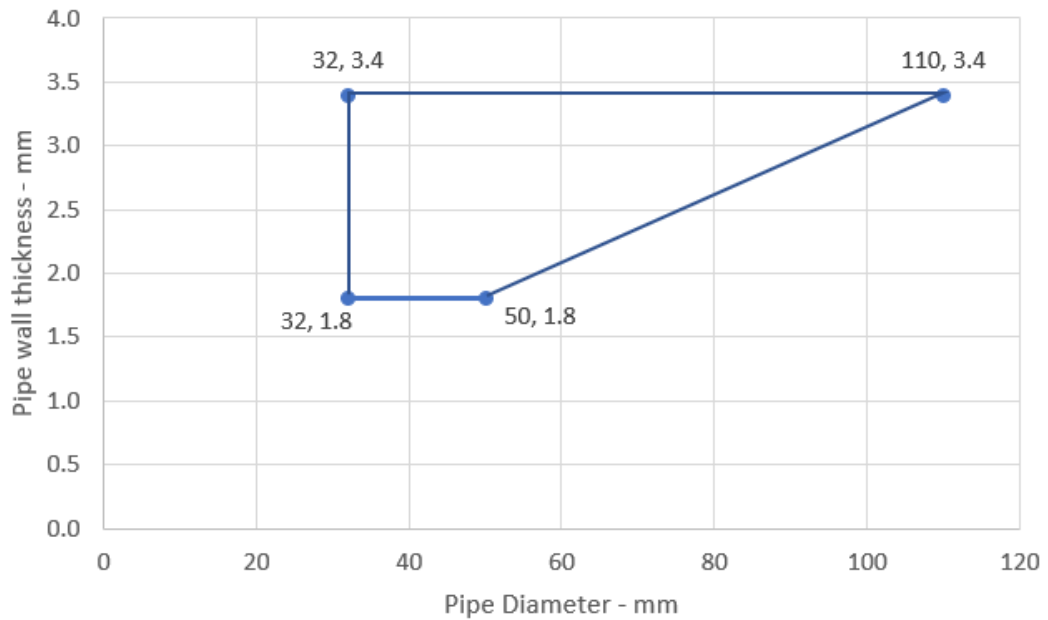

### Rehau Raupiano Plus -EI 120 U/C

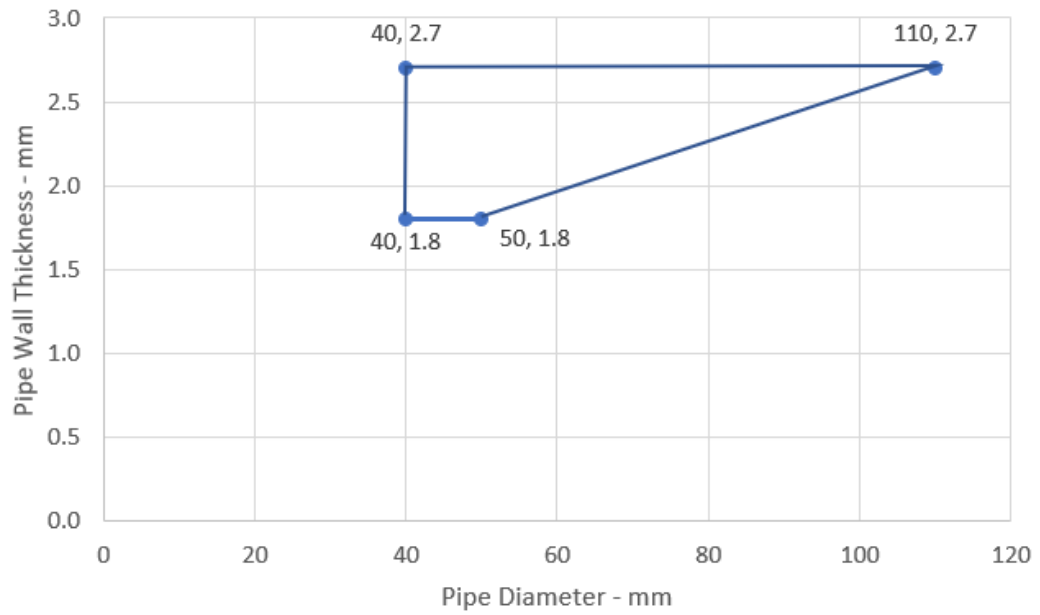

### Polo-Kal NG - EI 120 U/C

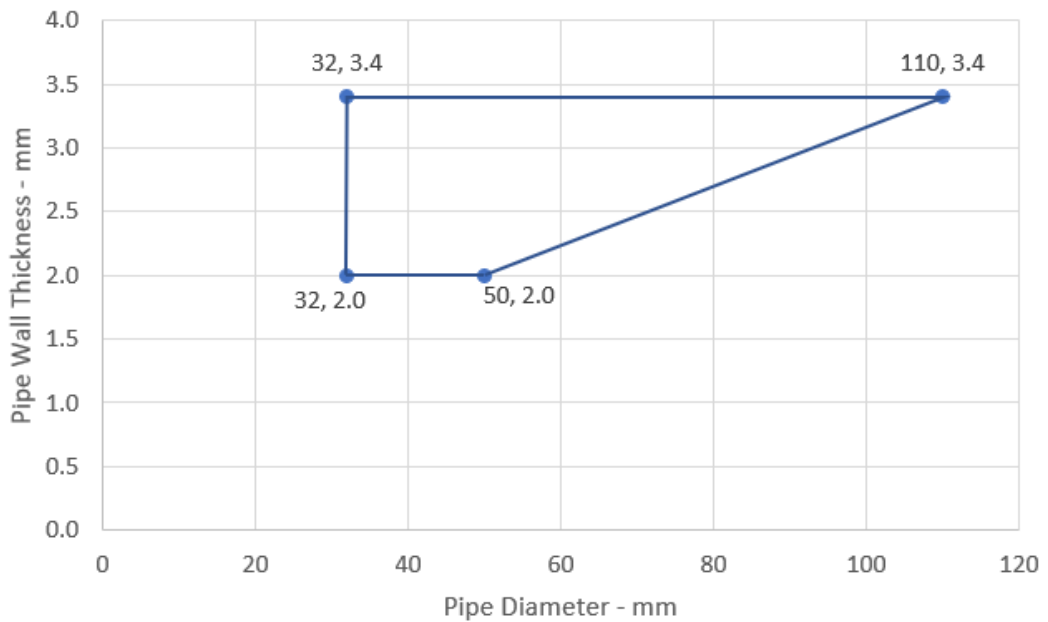



### Aquatherm Green - E 120 C/C, EI 90 C/C

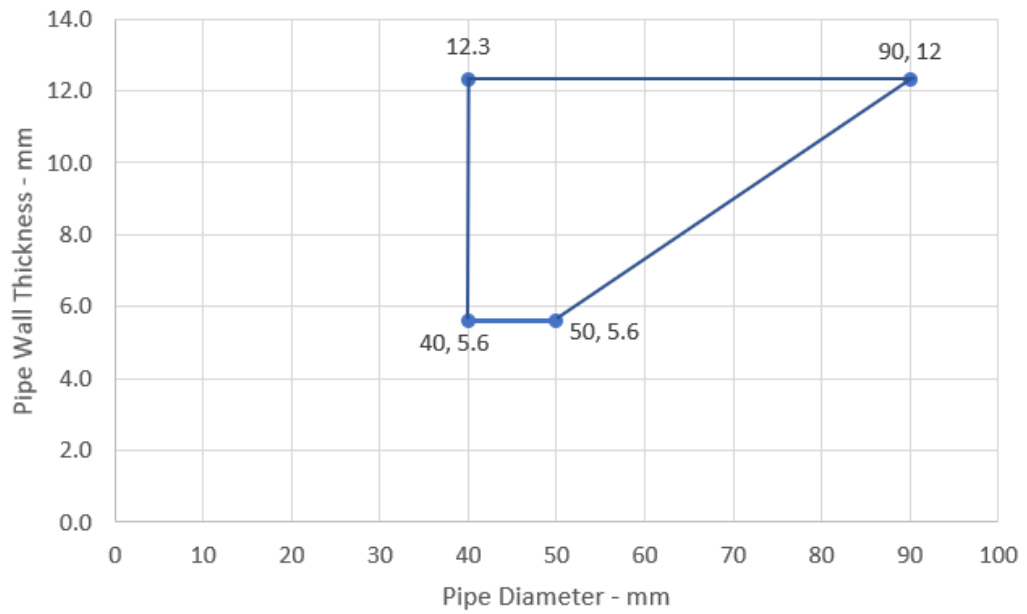

### Wavin SiTech Pipes - E120 C/C, EI 60 C/C

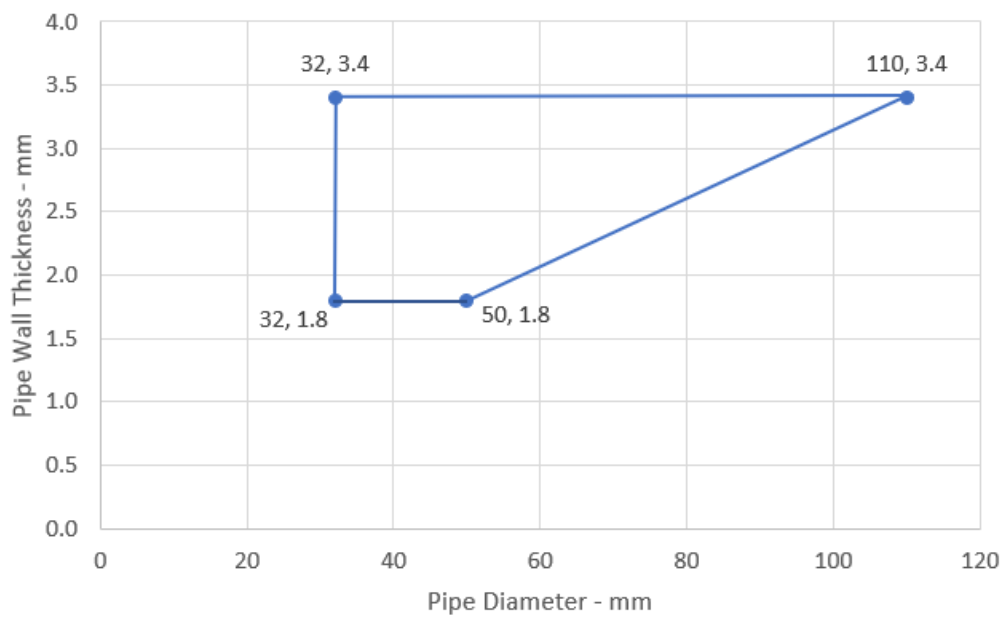

### Gilbert Silent PP - EI 120 U/C

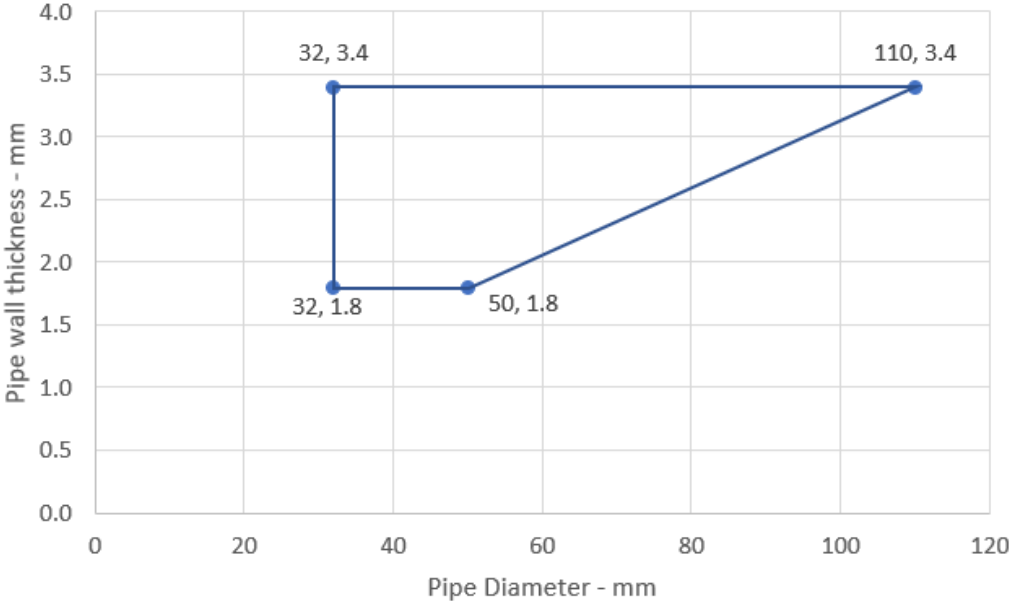

**A.6.6 Penetration seal in Tytan Professional B1 Fire Mortar Gypsum seals, in flexible\* and rigid walls minimum 100 mm thick**

**Penetration Seal:** Combustible pipes sealed with Tytan Professional B1 Fire Wrap , installed into Tytan Professional B1 Fire Mortar Gypsum seals. Minimum separation between penetration seals and seal edges of 30 mm.

Construction details:

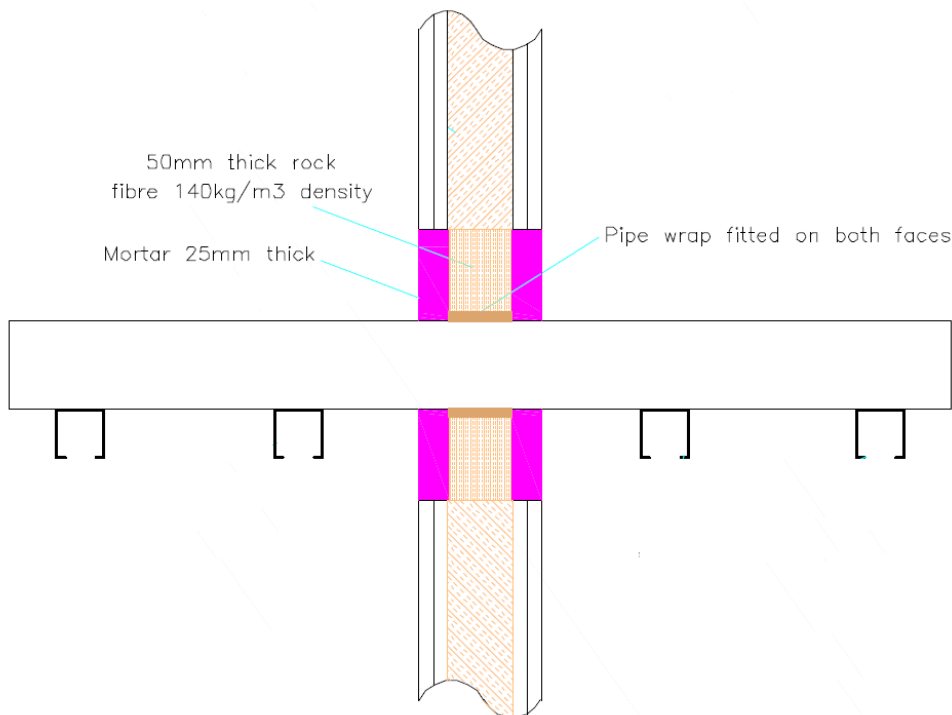

**Configuration 1**

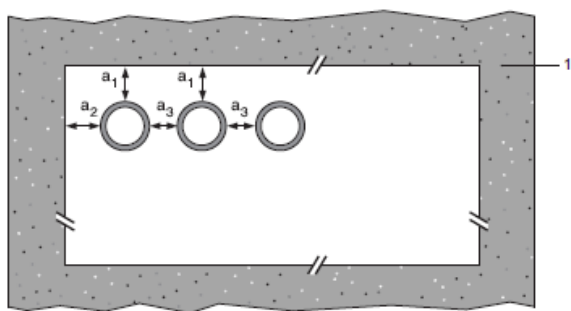

**Configuration 2**

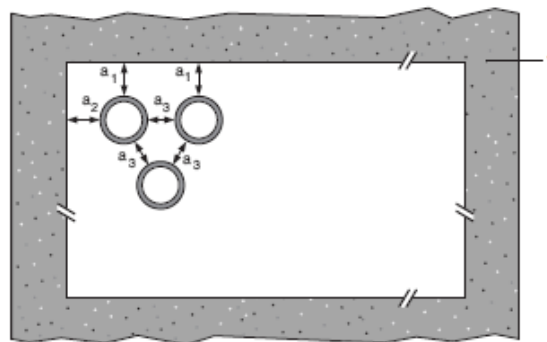

**Key**

- 1 Supporting construction
- a1 Pipe / top edge of seal separation
- a2 Pipe / side edge of seal separation
- a3 Pipe / pipe separation

**\* Partition wall must incorporate a full fill core insulation of Stonewool (35kg/m3 density)**

## A.6.6.1

Services	Wraps (both sides)	Permitted configuration for seal separation	Classification
PVC-U pipe according to EN 1329-1, EN 1452-2 and EN 1453-1 and PVC-C according to EN 1566-1			
Diameter up to 40 mm, wall thickness 3.0 – 4.3 mm	50 x 1.8 mm (1 layer)	1 & 2 between PVC-U/PVC-C, PE/ABS/SAN+PVC and PP pipes in any combination	E 120 U/C, E 120 C/U, EI 60 U/C, EI 60 C/C
Diameter up to 110 mm, wall thickness 2.7 - 6.6 mm	50 x 3.6 mm (2 x 1.8 layer)		E 120 U/C, E 120 C/C EI 90 U/C, EI 90 C/C
Diameter up to 125 mm, wall thickness 3.7 – 7.4 mm	50 x 5.4 mm (3 x 1.8 layer)		EI 120 U/C, EI 120 C/C
Diameter up to 160 mm, wall thickness 3.2 - 9.5 mm	50 x 7.2 mm (4 x 1.8 layer)		EI 60 U/C, EI 60 C/C
PE pipe according to EN 1519-1, EN 12201-2 and EN 12006-1, ABS according to EN 1455-1 and pipes made from SAN+PVC according to EN 1565-1			
Diameter up to 40 mm, wall thickness 3.2 – 3.7 mm	50 x 1.8 mm (1 layer)	1 & 2 between PVC-U/PVC-C, PE/ABS/SAN+PVC and PP pipes in any combination	EI 120 U/C, EI 120 C/C
Diameter up to 110 mm, wall thickness 4.2 - 10 mm	50 x 3.6 mm (2 x 1.8 layer)		EI 60 U/C, EI 60 C/C
Diameter up to 125 mm, wall thickness 12 mm	50 x 5.4 mm (3 x 1.8 layer)		EI 120 U/C, EI 120 C/C
Diameter up to 160 mm, wall thickness 4.9 – 12.0 mm	50 x 7.2 mm (4 x 1.8 layer)		E 120 U/C, E 120 C/C
Diameter up to 160 mm, wall thickness 12.0 mm			EI 90 U/C, EI 90 C/C
PP pipe according to EN 1852-1: 2009			
Diameter up to 40 mm, wall thickness 4.0 – 5.5 mm	50 x 1.8 mm (1 layer)	1 & 2 between PVC-U/PVC-C, PE/ABS/SAN+PVC and PP pipes in any combination	EI 120 U/C, EI 120 C/C
Diameter up to 110 mm, wall thickness 6.6 mm	50 x 3.6 mm (2 x 1.8 layer)		E 120 U/C, E 120 C/C EI 90 U/C, EI 90 C/C
Diameter up to 125 mm, wall thickness 17.1 mm	50 x 5.4 mm (3 x 1.8 layer)		E 120 U/C, E 120 C/C EI 90 U/C, EI 90 C/C
Diameter up to 160 mm, wall thickness 4.0 - 21.9 mm	50 x 7.2 mm (4 x 1.8 layer)		E 120 U/C, E 120 C/C
Diameter up to 160 mm, wall thickness 21.9 mm			EI 60 U/C, EI 60 C/C